

6.0-16.0V

Input

0.75-5.0V

Outputs

16 Amp

Current

Non

Isolated

SMT

Surface Mount

The NiQor SMT DC/DC converter is a non-isolated buck regulator, which employs synchronous rectification to achieve extremely high conversion efficiency. The NiQor family of converters are used predominately in DPA systems using a front end DC/DC high power brick (48Vin to low voltage bus). The non-isolated NiQor converters are then used at the point of load to create the low voltage outputs required by the design. The wide trim module can be programmed to a variety of output voltages through the use of a single external resistor. RoHS compliant (see page 12).

NiQor®

Non-Isolated



NiQor surface mount module

DOSA

Distributed-power
Open Standards Alliance

Operational Features

- Ultra high efficiency, up to 94% at full rated load
- Delivers up to 16 Amps of output current with minimal derating - no heatsink required
- Input Voltage Range : 6.0 - 16.0V
- Fast transient response time
- On-board input and output filter capacitor
- No minimum load requirement means - no preload resistors required

Mechanical Features

- DOSA standard SMT pin-out configuration
- Industry standard size: 1.3" x 0.53" x 0.29" (33 x 13.5 x 7.3 mm)
- Total weight: 0.18 oz. (5 grams), lower mass greatly reduces vibration and shock problems
- Open frame construction maximizes air flow cooling
- Also available in SIP packaging

Control Features

- On/Off control
- Output voltage trim (industry standard) permits custom voltages and voltage margining
- Remote Sense (standard option)

Protection Features

- Input under-voltage lockout disables converter at low input voltage conditions
- Temperature compensated over-current shutdown protects converter from excessive load current or short circuits
- Output over-voltage protection protects load from damaging voltages
- Thermal shutdown protects converter from abnormal environmental conditions

Safety Features

- UL 60950-1:2003
- CAN/CSA-C22.2 No. 60950-1:2003
- EN60950-1:2001
- RoHS compliant (see page 12)

Surface Mount Package

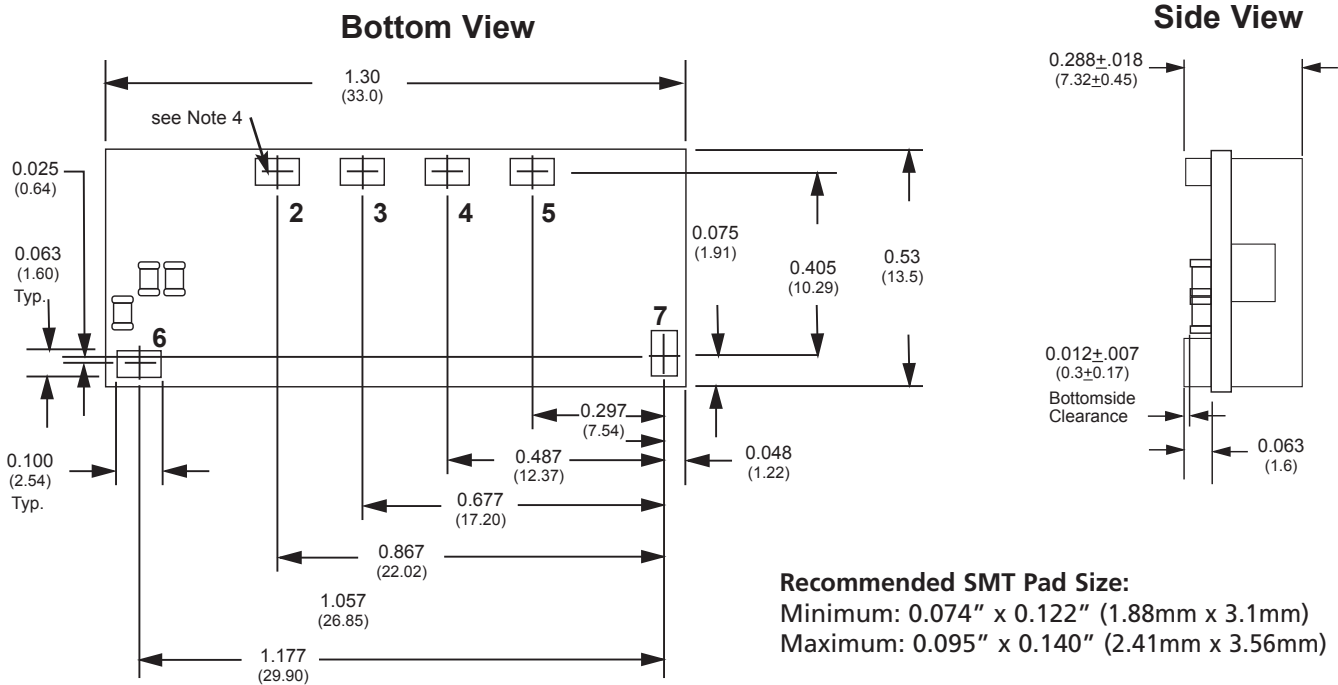

NOTES

- SMT Contacts: Material - Brass
Finish - Gold over Nickel plate
- Undimensioned components are shown for visual reference only.
- All dimensions in inches (mm)
Tolerances: x.xx +/-0.02 in. (x.x +/-0.5mm)
x.xxx +/-0.010 in. (x.xx +/-0.25mm)
- Coplanarity for pins 1-7 is 0.004" max
- Weight: 0.18 oz. (5 g) typical
- Workmanship: Meets or exceeds IPC-A-610C Class II

SMT CONTACT DESIGNATIONS

Pin	Designation	Description
2	GND	Ground
3	Vout(+)	Positive output voltage
4	TRIM	Output Voltage Trim
5	<i>SENSE(+)</i>	<i>Positive remote sense</i>
6	Vin(+)	Positive input voltage
7	ON/OFF	Input to turn converter on/off

Pins in Italics Shaded text are Optional

ELECTRICAL CHARACTERISTICS - NQ16W50SMA16

T_A=25°C, airflow rate=300 LFM, V_{in}=12Vdc unless otherwise noted; full operating temperature range is -40°C to +105°C ambient temperature with appropriate power derating. Specifications subject to change without notice.

Parameter	Vout	Min.	Typ.	Max.	Units	Notes & Conditions
ABSOLUTE MAXIMUM RATINGS						
Input Voltage						
Non-Operating	All	0		18	V	Continuous
Operating	All			16	V	Continuous
Operating Temperature	All	-40		105	°C	
Storage Temperature	All	-55		125	°C	
Voltage at ON/OFF input pin	All	-3		15	V	
RECOMMENDED OPERATING CONDITIONS						
Input Voltage Range	All	6		16	V	
Input Fuse Rating	All			20	A	Fast blow external fuse recommended
External Input Capacitance	All	100			µF	ESR<1.5Ω
Output Voltage	All	0.75		5.5	V	
Output Current	All	0		16	A	
INPUT CHARACTERISTICS						
Input Under-Voltage Lockout						
Turn-On Voltage Threshold	All	5.35	5.73	6.10	V	
Turn-Off Voltage Threshold	All	4.50	4.73	4.95	V	
Lockout Hysteresis	All		1		V	
Maximum Input Current	0.75V			2.8	A	6Vin, 100% load
"	2.5V			7.5	A	"
"	5.0V			14.0	A	"
No-Load Input Current	0.75V		31		mA	12Vin
"	2.5V		71		mA	"
"	5.0V		132		mA	"
Disabled Input Current	All		3		mA	
Inrush Current Transient Rating	All			0.1	A ² s	With min. output capacitance
Input Filter Capacitor Value	All		30		µF	
Input Reflected-Ripple Current	0.75V		36		mA	12Vin, 100% load, pk-pk value
"	2.5V		68		mA	"
"	5.0V		98		mA	"
OUTPUT CHARACTERISTICS						
Output Voltage Set Point	0.75V	0.745	0.75	0.755	V	12Vin 50% load
Output Voltage Range	All	0.75		5.0	V	Set output by Rtrim-up
Operating Output Current Range	All	0		16	A	
Output Voltage Regulation						
Over Line	All			0.5	%	With sense pin
Over Load	All			0.5	%	"
Over Temperature	All			1	%	"
Total Output Voltage Range	All			3	%	With sense pin, over sample, line, load, temp. & life
Output Voltage Ripple and Noise (pk-pk)RMS	1.0V		27\5.0		mV	Full load; 20MHz bandwidth
"	2.5V		43\11.6		mV	"
"	5.0V		67\20.4		mV	"
Output DC Over Current Shutdown	All	20	24	28	A	
External Output Capacitance	All	100		5000	µF	>0.5mΩ
DYNAMIC CHARACTERISTICS						
Input Voltage Ripple Rejection	All		50		dB	120Hz
Output Voltage during Current Transient						
For a Step Change in Output Current (0.1A/µs)	All		180		mV	50%-75%-50% Iout max; 100µF
For a Step Change in Output Current (3A/µs)	All		180		mV	50%-75%-50% Iout max; 470µF
Settling Time	All		100		µs	To within 1.5% Vout nom.
Turn on Transient						
Inhibit Time	All	2		4	ms	Resistive load
Rise Time	All	2		6	ms	"
Output Voltage Overshoot	All			0	V	"
EFFICIENCY						
100% Load	0.75V		77.0		%	
"	2.5V		90.0		%	
"	5.0V		94.0		%	
50% Load	0.75V		81.0		%	
"	2.5V		91.5		%	
"	5.0V		94.0		%	

ELECTRICAL CHARACTERISTICS (continued) - NQ16W50SMA16

Parameter	Vout	Min.	Typ.	Max.	Units	Notes & Conditions
TEMP LIMITS FOR POWER DERATING						
Semiconductor Junction Temperature	All			125	°C	Package rated to 150°C
Board Temperature	All			125	°C	UL rated max operating temp 130°C
FEATURE CHARACTERISTICS						
Switching Frequency	All	275	300	325	kHz	Half on small duty cycle (e.g. 16Vin; 0.75Vout)
ON/OFF Control						
Open Logic (O) ON/OFF Control						See Figure A
Off-State Voltage	All	1.5		6.5	V	
On-State Voltage	All	-3.0		0.6	V	
Input Resistance	All		20		kΩ	
Positive Logic (P) ON/OFF Control						Open collector/drain input; see Figure A
Logic Low Voltage Range	All	-0.2		1.0	V	
Logic High Voltage Range (internal pullup)	All	2.2		Vin	V	
Pull-up Voltage	All		5		V	
Pull-up Resistance	All		100		kΩ	
Output Voltage Trim Range	All	0.75		5.5	V	Measured Vout+ to common pins
Output Over-Voltage Protection	All	5.6	6.0	6.4	V	Over full temp range
Over-Temperature Shutdown	All		128		°C	Average PCB Temperature
Over-Temperature Shutdown Restart Hysteresis	All		10		°C	
RELIABILITY CHARACTERISTICS						
Calculated MTBF (Telcordia)	All		15.6		10 ⁶ Hrs.	TR-NWT-000332; 100% load, 200LFM, 40°C T _a
Calculated MTBF (MIL-217)	All		10.0		10 ⁶ Hrs.	MIL-HDBK-217F; 100% load, 200LFM, 40°C T _a
Field Demonstrated MTBF	All				10 ⁶ Hrs.	See our website for details

STANDARDS COMPLIANCE

Parameter	Notes & Conditions
STANDARDS COMPLIANCE	
UL 60950-1:2007	Basic insulation
EN60950-1/A11:2009/A1:2010	
CAN/CSA-C22.2 No. 60950-1:2007	
IEC 61000-4-2	ESD test, 8 kV - NP, 15 kV air - NP (Normal Performance)

Note: An external input fuse must always be used to meet these safety requirements. Contact SynQor for official safety certificates on new releases or download from the SynQor website.

QUALIFICATION TESTING

Parameter	# Units	Test Conditions
QUALIFICATION TESTING		
Life Test	32	95% rated Vin and load, units at derating point, 1000 hours
Vibration	5	10-55 Hz sweep, 0.060" total excursion, 1 min./sweep, 120 sweeps for 3 axis
Mechanical Shock	5	100g minimum, 2 drops in x, y and z axis
Temperature Cycling	10	-40 °C to 100 °C, unit temp. ramp 15 °C/min., 500 cycles
Power/Thermal Cycling	5	Toperating = min to max, Vin = min to max, full load, 100 cycles
Design Marginality	5	Tmin-10 °C to Tmax+10 °C, 5 °C steps, Vin = min to max, 0-105% load
Humidity	5	85 °C, 85% RH, 1000 hours, continuous Vin applied except 5 min/day
Solderability	15 pins	MIL-STD-883, method 2003

OPTIONS

SynQor provides various options for Packaging, Enable Logic, and Feature Set for this family of DC/DC converters. Please consult the last page for information on available options.

PATENTS

SynQor is protected under various patents. Please consult page 12 for further details.

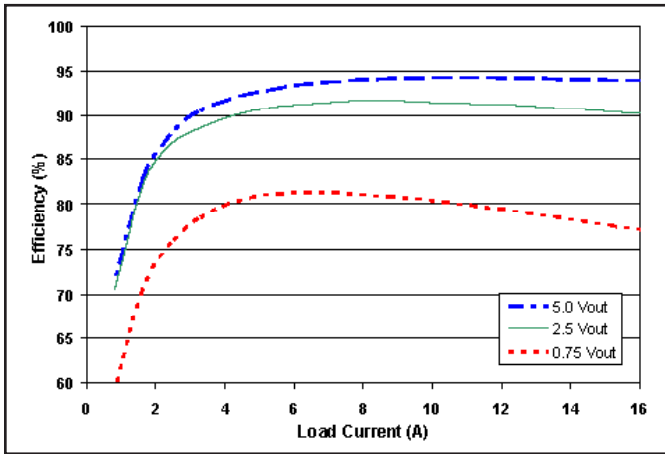

Figure 1: Efficiency at nominal output voltage vs. load current for nominal input voltage at 25°C.

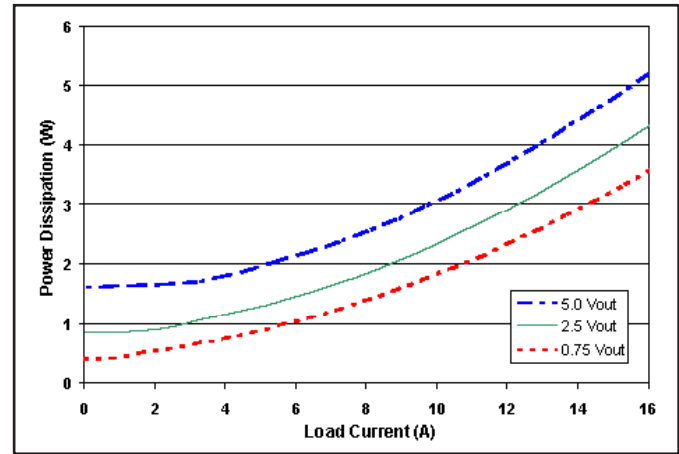

Figure 2: Power dissipation at nominal output voltage vs. load current for nominal input voltage at 25°C.

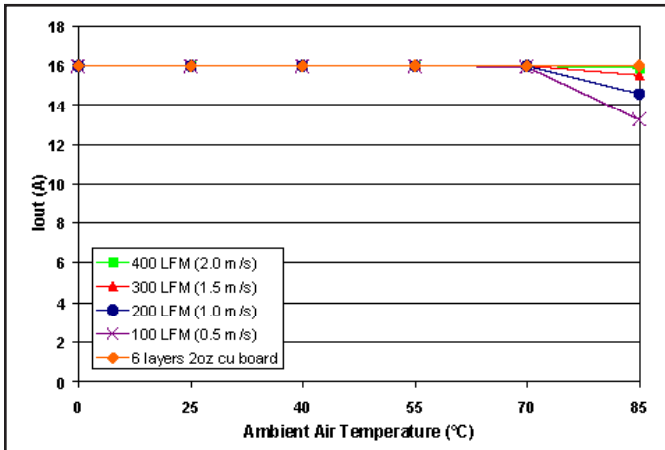

Figure 3: Maximum output power derating curves for 0.75Vo, 1.2Vo, 1.5Vo units under various thermal conditions and nominal input voltage. See Thermal Considerations section for more details.

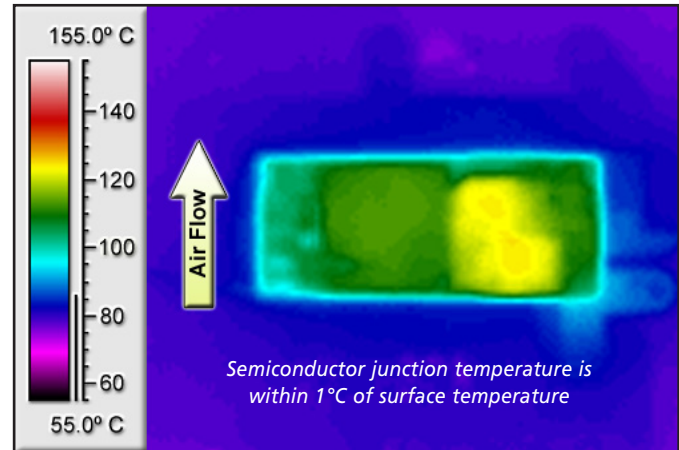

Figure 4: Thermal plot of 0.75Vo, 1.2Vo converters at nominal Vin and 16 amp load current mounted on a 85°C, 6-Layer, 2 oz. copper board (typical installation).

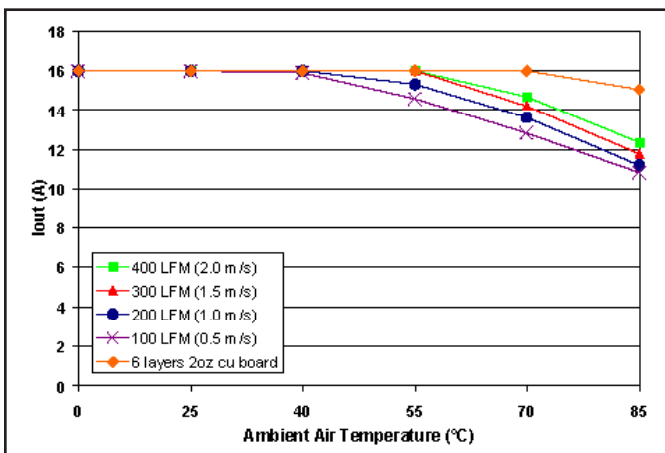

Figure 5: Maximum output power derating curves for 1.8Vo, 2.5Vo units under various thermal conditions and nominal input voltage. See Thermal Considerations section for more details.

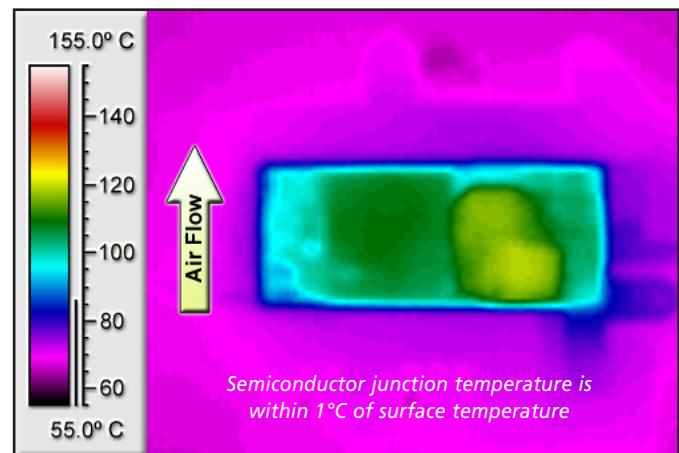

Figure 6: Thermal plot of 1.8Vo, 2.5Vo converters at nominal Vin and 16 amp load current mounted on a 70°C, 6-Layer, 2 oz. copper board (typical installation).

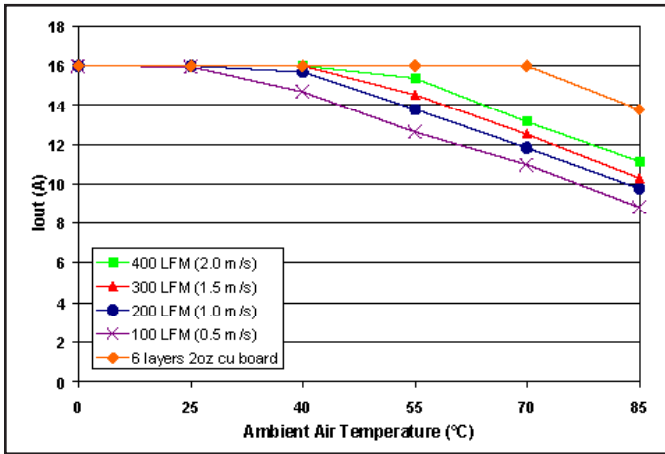

Figure 7: Maximum output power derating curves for 3.3Vo, 5.0Vo units under various thermal conditions and nominal input voltage. See Thermal Considerations section for more details.

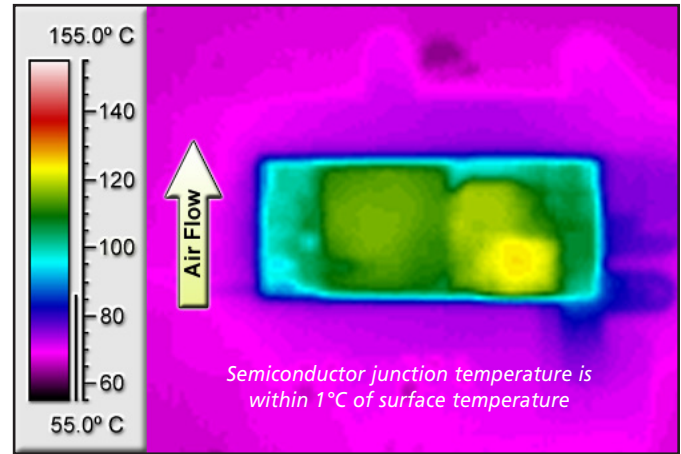

Figure 8: Thermal plot of 3.3Vo, 5.0Vo converters at nominal Vin and 16 amp load current mounted on a 70°C, 6-Layer, 2 oz. copper board (typical installation).

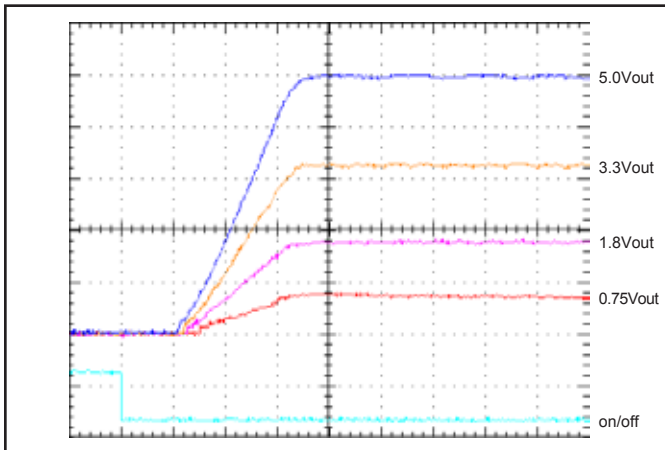

Figure 9: Turn-on transient at full load (resistive load) (2 ms/div).
 Ch 1: ON/OFF input (5V/div)
 Ch 2-4: Vout (1V/div)

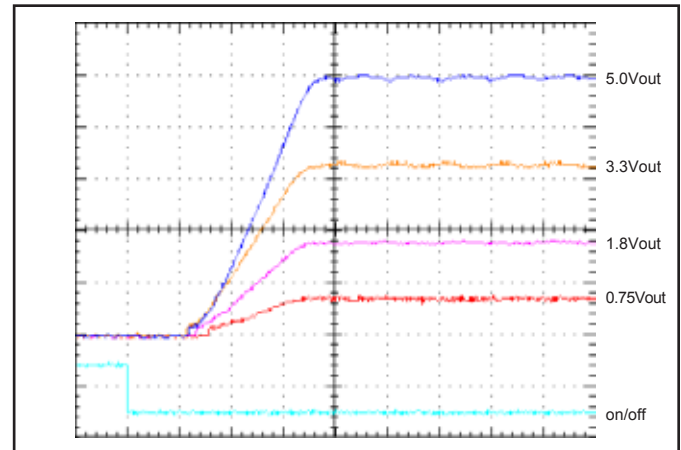

Figure 10: Turn-on transient at zero load (2 ms/div).
 Ch 1: ON/OFF input (5V/div)
 Ch 2-4: Vout (1V/div)

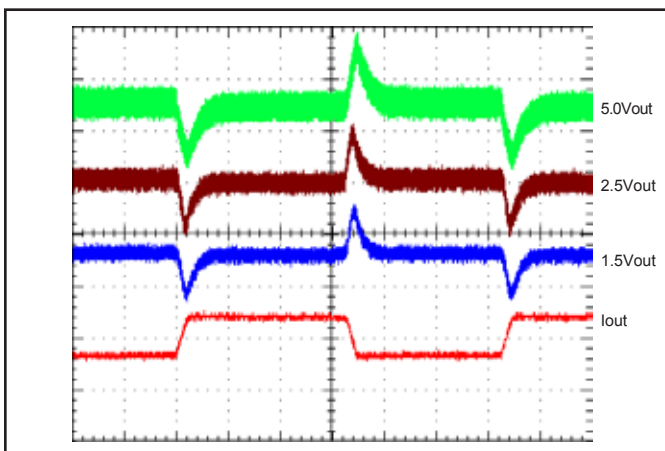

Figure 11: Output voltage response for 1.5V, 2.5V, 5V units to step-change in load current (50-75-50% of Iout max; di/dt=0.1A/us). Load cap: 100µF, 100mΩ ESR tant, 10µF cer. Ch 1: Iout (10A/div), Ch 2-4: Vout (100mV/div).

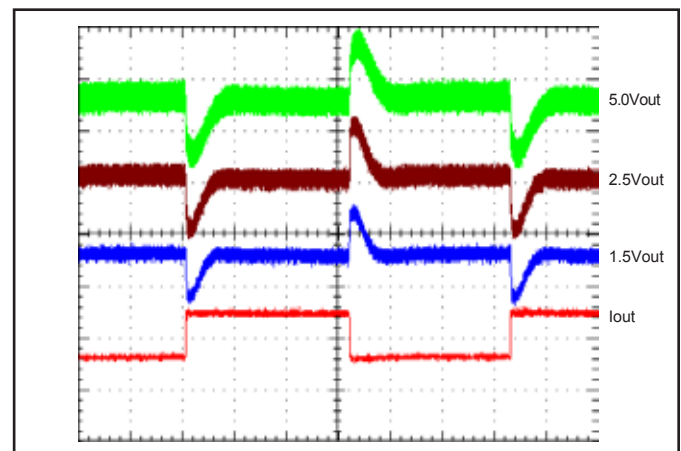

Figure 12: Output voltage response for 1.5V, 2.5V, 5V units to step-change in load current (50-75-50% of Iout max; di/dt=3A/us). Load cap: 470µF, 100mΩ ESR tant, 10µF cer. Ch 1: Iout (10A/div), Ch 2-4: Vout (100mV/div).

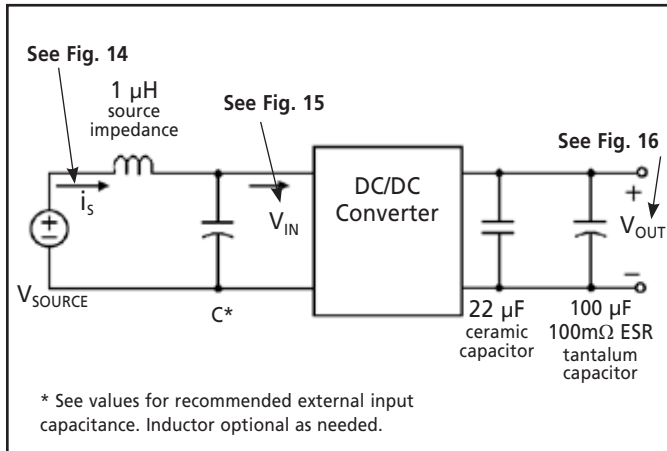

Figure 13: Test set-up diagram showing measurement points for Input Reflected Ripple Current (Figure 14), Input Terminal Ripple Voltage (Figure 15), and Output Voltage Ripple (Figure 16).

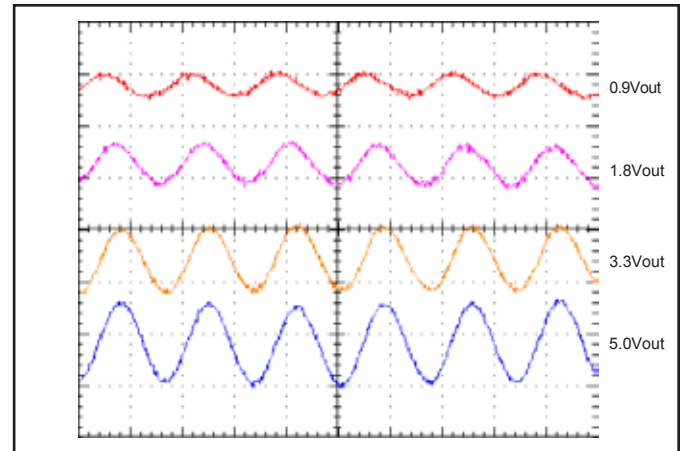

Figure 14: Input Reflected Ripple Current, i_s , through a $1\ \mu\text{H}$ source inductor at nominal input voltage and rated load current (100 mA/div). See Figure 13.

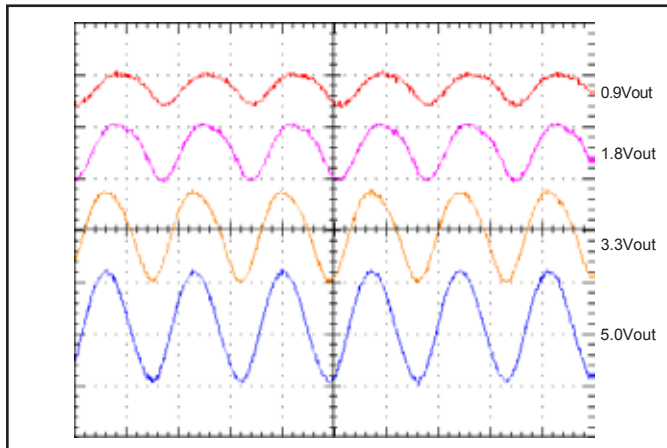

Figure 15: Input Terminal Ripple Voltage at nominal input voltage and rated load current (200 mV/div). Load capacitance: $22\ \mu\text{F}$ ceramic cap and $100\ \mu\text{F}$ tantalum cap. Bandwidth: 20 MHz. See Figure 13.

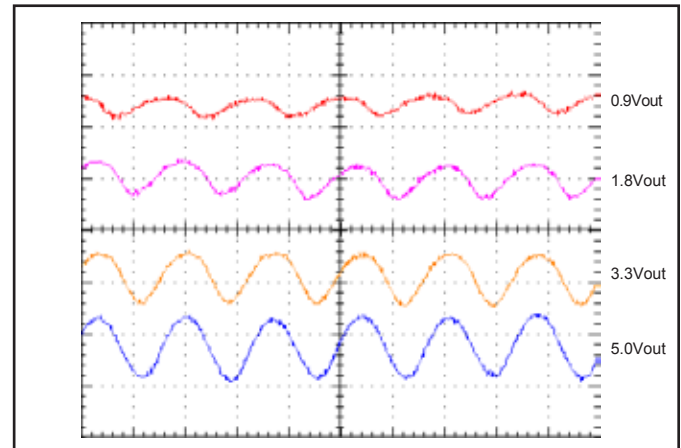

Figure 16: Output Voltage Ripple at nominal input voltage and rated load current (50 mV/div). Load capacitance: $22\ \mu\text{F}$ ceramic cap and $100\ \mu\text{F}$ tantalum cap. Bandwidth: 20 MHz. See Figure 13.

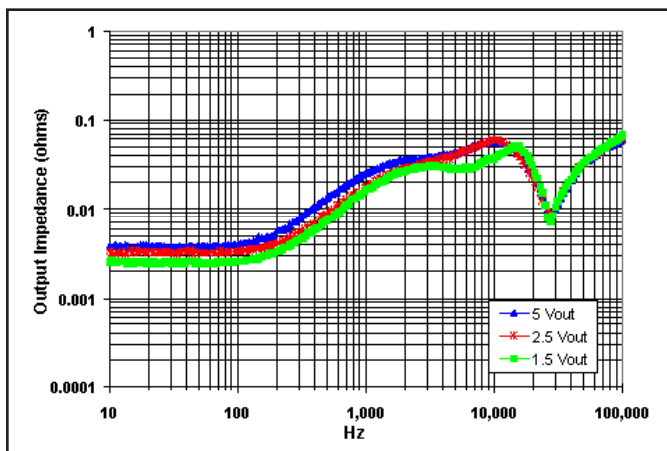

Figure 17: Magnitude of incremental output impedance ($Z_{out} = v_{out}/i_{out}$) for nominal input voltage at full rated power with $100\ \mu\text{F}$ tantalum output capacitor.

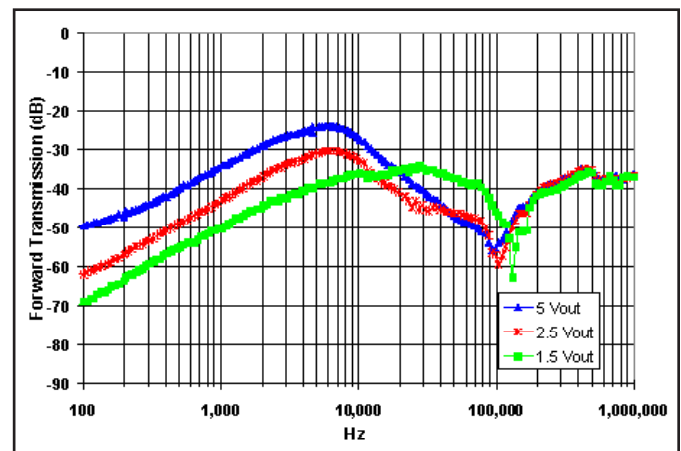

Figure 18: Magnitude of incremental forward transmission ($FT = v_{out}/v_{in}$) for nominal input voltage at full rated power with $100\ \mu\text{F}$ tantalum output capacitor.

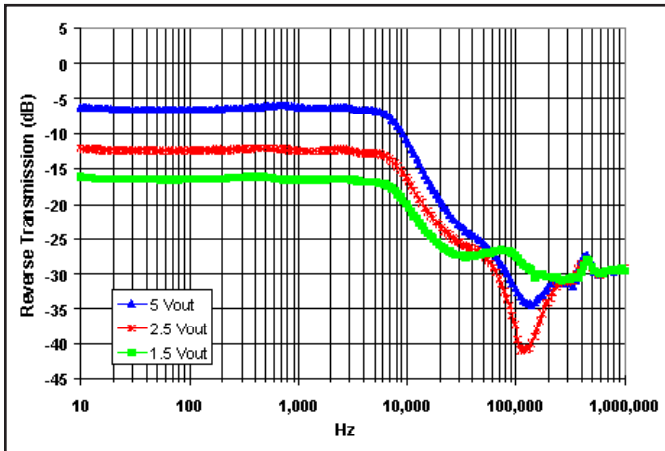

Figure 19: Magnitude of incremental reverse transmission ($RT = i_{in}/i_{out}$) for nominal input voltage at full rated power with $100\mu\text{F}$ tantalum output capacitor.

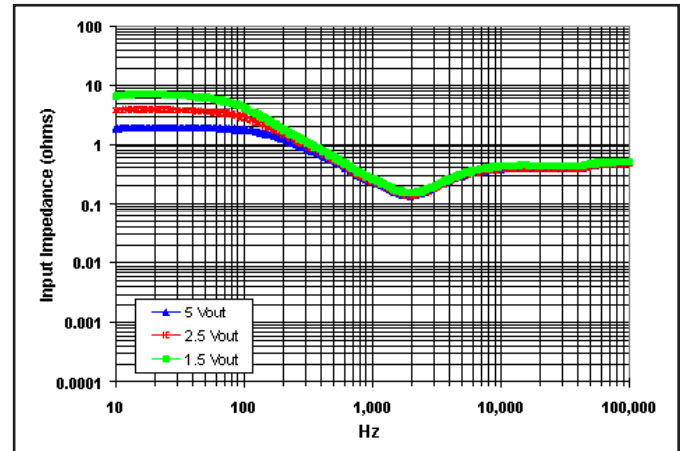

Figure 20: Magnitude of incremental input impedance ($Z_{in} = v_{in}/i_{in}$) for nominal input voltage at full rated power with $100\mu\text{F}$ tantalum output capacitor.

BASIC OPERATION AND FEATURES

The NiQor series non-isolated converter uses a buck-converter that keeps the output voltage constant over variations in line, load, and temperature. The NiQor modules employ synchronous rectification for very high efficiency.

Dissipation throughout the converter is so low that it does not require a heatsink or metal baseplate for operation. The NiQor converter can thus be built more simply and reliably using high yield surface mount techniques on a single PCB substrate.

The NiQor series of SIPs and SMT converters uses the established industry standard footprint and pin-out configurations.

CONTROL FEATURES

REMOTE ON/OFF: The ON/OFF input permits the user to control when the converter is on or off. There are currently two options available for the ON/OFF input described in the table below. Others may become available if demand exists.

Option	Description	Pin-Open Float Voltage	Pin-Open Converter State	Pin Action
P Logic	Positive/Open	5	On	Pull Low = Off
N Logic	Negative/Open	0	On	Pull High = Off

OUTPUT VOLTAGE TRIM: The TRIM input permits the user to adjust the output voltage according to the trim range specifications by using an external resistor. If the TRIM feature is not being used, leave the TRIM pin disconnected.

TRIM-UP: To increase the output voltage from the nominal setpoint of 0.7525V using an external resistor, connect the resistor $R_{trim-up}$ between the TRIM and the Ground pin according to the diagram below.

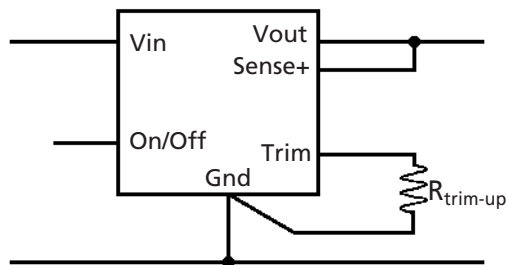

For a desired increase of the nominal output voltage, the value of the resistor should be:

$$R_{trim-up} = \frac{10500}{V_{DES} - 0.7525} - 1000 \quad (\Omega)$$

or

$$V_{OUT} = 0.7525 + \frac{10500}{R_{trim-up} + 1000} \quad (\Omega)$$

where V_{DES} = Desired Output Voltage

To maintain the accuracy of the output voltage over load current, it is vital that any trim-up resistor be terminated directly to the converter's ground foot, not at the connection to the load. A separate Kelvin connection to the PCB pad for the ground foot is optimal. Trim-down resistors should be terminated at the converter's Sense+ pin.

We do not recommend bypassing the trim pin directly to ground with a capacitor. The voltage gain from the trim pin to output is rather large, 15:1. Ground bounce through a bypass capacitor could introduce significant noise to the converter's control circuit.

PROTECTION FEATURES

Input Under-Voltage Lockout: The converter is designed to turn off when the input voltage is too low, helping avoid an input system instability problem, described in more detail in the application note titled "Input System Instability". The lockout circuitry is a comparator with DC hysteresis. When the input voltage is rising, it must exceed the typical Turn-On Voltage Threshold value (listed on the specification page) before the converter will turn on. Once the converter is on, the input voltage must fall below the typical Turn-Off Voltage Threshold value before the converter will turn off.

Output Current Limiting: To provide protection in an output over load fault condition, the unit is equipped with internal over-current protection. When the over-current protection is triggered, the unit enters hiccup mode. The units operate normally once the fault condition is removed.

Internal Over-Voltage Protection: To fully protect from excessive output voltage, the NQ16 series contains an Output Over-Voltage Shutdown circuitry.

This OVP is independent of the trimmed setpoint. As such, the converter's load is protected from faults in the external trim circuitry (such as a trim pin shorted to ground). Since the setpoint of this OVP does not track trim, it is set at 6.0V, in the wide-trim W50 model.

The shutdown point is fixed on standard option. SMA also offers adjustable OVP set point. For more detailed information contact SynQor technical support.

Over-Temperature Shutdown: A temperature sensor on the converter senses the average temperature of the module. The thermal shutdown circuit is designed to turn the converter off when the temperature at the sensed location reaches the Over-Temperature Shutdown value. It will allow the converter to turn on again when the temperature of the sensed location falls by the amount of the Over-Temperature Shutdown Restart Hysteresis value.

APPLICATION CONSIDERATIONS

Input Filtering/Capacitance/Damping: The filter circuit of Figure E is often added to the converter's input to prevent switching noise from reaching the input voltage bus.

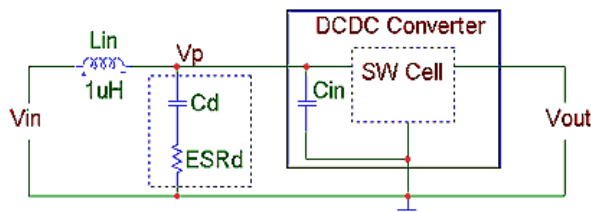

Figure E: NQ16 converter with Input Filter

In the SMA16 (surface mount) converters $C_{in} = 30\mu\text{F}$ of high quality ceramic capacitors. With L_{in} of $1\mu\text{H}$, C_d should be $100\text{-}200\mu\text{F}$ and R_d should be $0.1\text{-}0.2\Omega$, in most applications. For more information on designing the input filter and choosing proper values, contact SynQor technical support.

Adding significant external pure ceramic capacitance directly across the converter's input pins is not recommended. Parasitic inductance associated with the input pin geometry and PCB traces can create a high-Q CLC circuit with any external capacitors. Just a few nano-Henries of parasitic inductance can create a resonance (or an overtone) near the converter's switching frequency. C_{in} has a reactance of $10\text{-}20\text{m}\Omega$ at the 300kHz switching frequency. To avoid this high-frequency resonance, any external input filter should exhibit a net source impedance of at least $20\text{m}\Omega$ resistive through this frequency range. This requirement is easily met with the damping elements discussed above. Adding a small amount (a few μF) of high-frequency external ceramic will not violate it.

If using converters at higher powers, consider the ripple current rating of C_d . Contact SynQor technical support for details.

Output Capacitance: It is recommended to add at least $100\mu\text{F}$ of capacitance, with an ESR in the 0.1Ω range, to the output of the SMA16 series of converters. The VMA16 series has this capacitance included internally. In many applications, however, additional external output capacitance is required to reduce the response to load transients to an allowable level.

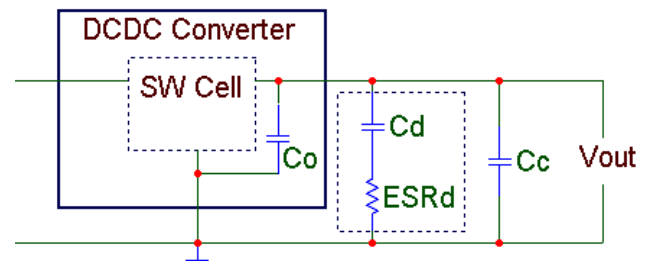

Figure F: Converter with Additional Output Capacitance

Thermal Performance (SMA16): While impossible to be exact, a simplified thermal model for the mounted converter is detailed below.

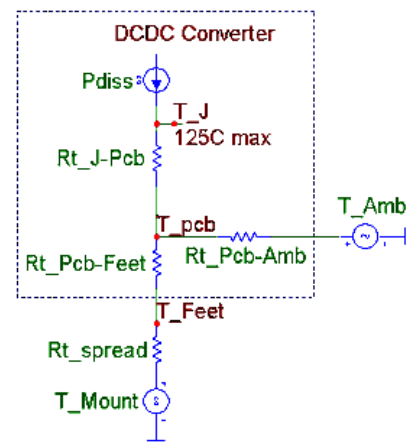

Figure G: Thermal Model for NQ16 Surface Mount

- $R_{t_J\text{-Pcb}}$ models the conduction of heat from the converter's hottest junction to the converter's PCB at large. It is about 3°C/W for converters running at higher output voltage, and about 4°C/W for lower voltage converters.
- $R_{t_Pcb\text{-Amb}}$ models the power dissipation from converter PCB to the air stream. It ranges from about 15°C/W at 400LFM to about 25°C/W 100LFM .
- $R_{t_Pcb\text{-Feet}}$ expresses the thermal path from the converter's PCB through its mounting feet; it is about 3°C/W .
- R_{t_spread} models the heat spreading on the PCB to which the converter is mounted and is largely dependent upon the construction and layout of that PCB.
- T_{mount} is the temperature of that PCB in the greater vicinity of the converter.

As is evident, the values for R_{t_spread} and T_{mount} will have great effect upon the thermal operation of the converter. With $R_{t_Pcb-Amb}$ being 5 to 8 times as large as $R_{t_Pcb-Feet}$, in most applications these converters will be predominantly cooled via thermal conduction through their feet. Airflow and T_{Amb} will have only a minimal cooling effect.

- R_{t_spread} should be minimized. Attach the converter to large copper planes, on multiple layers, with multiple vias near the mounting feet.
- T_{mount} should also be minimized. Place the converter far enough away from other sources of heat on the PCB so that it is as cool as practical.
- If operation near derating limits is even suspected, thermal performance should be verified with the unit mounted in its intended manner and powered in circuit with all neighboring circuitry active. Attach a thermocouple to the converter's hotspot as shown in Figures 4, 6, and 8 in the Performance Curves section.

SURFACE MOUNT INFORMATION

PCB Layout Considerations: SynQor recommends that the customer use a non-solder mask defined pad design. The minimum recommended pad size is 0.074" x 0.122" (1.88mm x 3.1mm) and the maximum pad size is 0.095" x 0.140" (2.41mm x 3.56mm), see the mechanical diagram on page 2. Interconnection to internal power planes is typically required. This can be accomplished by placing a number of vias between the SMT pad and the relevant plane. The number and location of the vias should be determined based on electrical resistance, current and thermal requirements. "Via-in-pad" design should be avoided in the SMT pads. Solder mask should be used to eliminate solder wicking into the vias.

Pick and Place: The NiQor surface mount modules are designed for automated assembly using standard SMT pick and place equipment. The modules have a centrally located inductor component with a flat surface area to be used for component pick-up. The units use open frame construction and have a low mass that is within the capability of standard pick and place equipment. Those modules however have a larger mass than most conventional SMT components and so variables such as nozzle size, tip style, handling speed, and placement pressure should be optimized for best results. A conformed tipped placement nozzle design is recommended. Coplanarity of better than 0.004" (0.1mm) is achieved through the SMT NiQor's terminal design.

Reflow Soldering Guidelines: Figure H shows a typical reflow profile for a eutectic solder process. Due to variations in customer applications, materials and processes, it is not feasible for SynQor to recommend a specific reflow profile. The customer should use this profile as a guideline only. Since the NiQor surface mount modules have a larger thermal mass and lower thermal resistance than standard SMT components, it may be necessary to optimize the solder reflow profile based on limitations of the other components on the customer board. Sufficient reflow time must be allowed to fuse the plating on the connection to ensure a reliable solder joint. The solder reflow profile should be confirmed by accurately measuring the SMT interconnect leads. Maximum case temperature of 260°C (exposure for 5 seconds or less) is not exceeded for the NiQor units.

Moisture Sensitivity: The NiQor surface mount modules have an MSL rating 1 per IPC/JEDEC J-STD-033A.

Cleaning and Drying: When possible, a no-clean solder paste system should be used to solder the NiQor SMT units to their application board. The modules are suitable for aqueous washing, however, the user must ensure sufficient drying to remove all water from the converter before powering up. Inadequate cleaning and drying can affect the reliability of the converter and the testing of the final assembly.

RoHS Compliance: The EU led RoHS (Restriction of Hazardous Substances) Directive bans the use of Lead, Cadmium, Hexavalent Chromium, Mercury, Polybrominated Biphenyls (PBB), and Polybrominated Diphenyl Ether (PBDE) in Electrical and Electronic Equipment. This SynQor product is 6/6 RoHS compliant. For more information please refer to SynQor's RoHS addendum available at our RoHS Compliance / Lead Free Initiative web page or e-mail us at rohs@synqor.com.

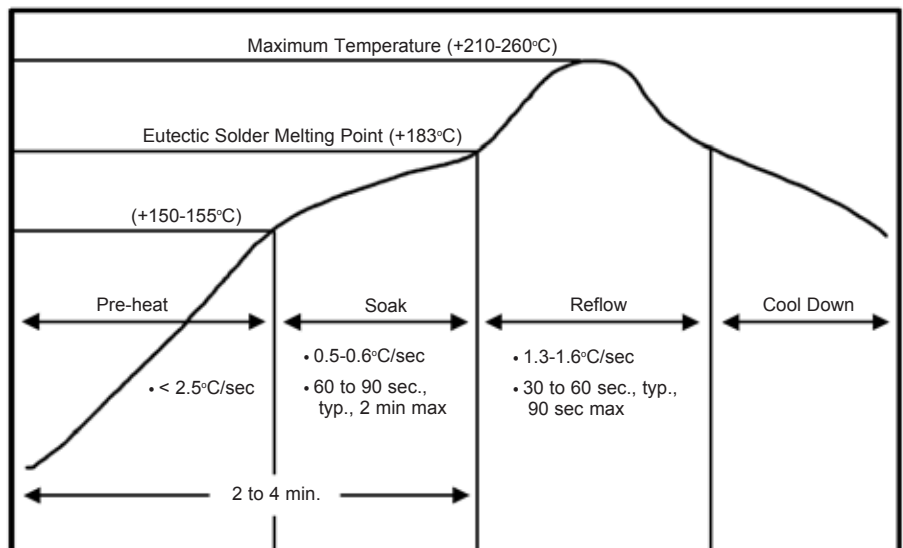

Figure H: Typical Eutectic (96.5Sn/3.0Ag/0.5Cu) Solder Profile



Technical Specification

Input: 6.0 - 16.0V
Outputs: 0.75 - 5.0V
Current: 16A
Package: SMT

PART NUMBERING SYSTEM

The part numbering system for SynQor's NiQor DC/DC converters follows the format shown in the example below.

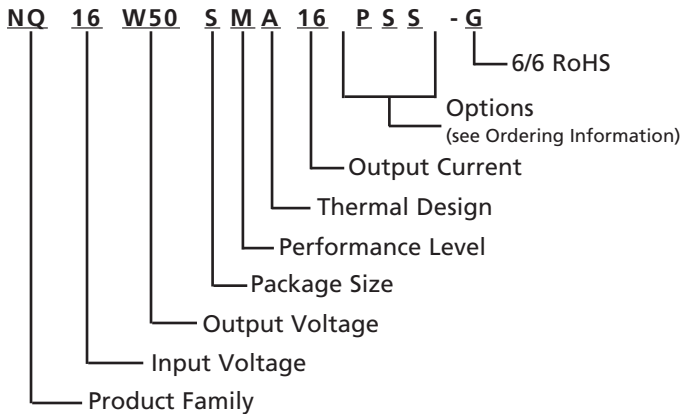

The first 12 characters comprise the base part number and the last 3 characters indicate available options. A "-G" suffix indicates the product is 6/6 RoHS compliant.

Application Notes

A variety of application notes and technical white papers can be downloaded in pdf format from our website.

ORDERING INFORMATION

The tables below show the valid model numbers and ordering options for converters in this product family. When ordering SynQor converters, please ensure that you use the complete 15 character part number consisting of the 12 character base part number and the additional 3 characters for options. A "-G" suffix indicates the product is 6/6 RoHS compliant.

Model Number	Input Voltage	Output Voltage	Max Output Current
NQ16W50SMA16xyz-G	6.0 - 16.0 V	0.75-5.0 V	16 A

The following option choices must be included in place of the x y z spaces in the model numbers listed above.

Options Description: x y z		
Enable Logic	Pin Style	Feature Set
P - Pos/Open O - Neg/Open	S - Standard	S - Sense N - None

PATENTS

SynQor holds the following U.S. patents, one or more of which apply to each product listed in this document. Additional patent applications may be pending or filed in the future.

5,999,417	6,222,742	6,545,890	6,577,109	6,594,159	6,731,520	6,894,468
6,896,526	6,927,987	7,050,309	7,072,190	7,085,146	7,119,524	7,269,034
7,272,021	7,272,023	7,558,083	7,564,702	7,765,687	7,787,261	8,023,290

Contact SynQor for further information:

Phone: 978-849-0600
Toll Free: 888-567-9596
Fax: 978-849-0602
E-mail: power@synqor.com
Web: www.synqor.com
Address: 155 Swanson Road
 Boxborough, MA 01719
 USA

Warranty

SynQor offers a three (3) year limited warranty. Complete warranty information is listed on our website or is available upon request from SynQor.

Information furnished by SynQor is believed to be accurate and reliable. However, no responsibility is assumed by SynQor for its use, nor for any infringements of patents or other rights of third parties which may result from its use. No license is granted by implication or otherwise under any patent or patent rights of SynQor.