

**48Vin
Input**

**5.0/3.3V
Outputs**

**60 Watt
Power**

**2000Vdc
Isolation**

**Quarter-brick
DC/DC Converter**

The DQ65033QMA06 DualQor™ Mega series is a dual output converter that uses the industry standard quarter brick package size. The very high efficiency is a result of SynQor's patented topology that uses synchronous rectification and an innovative construction design to minimize heat dissipation and allow extremely high power densities. The power dissipated by the converter is so low that a heatsink is not required, which saves cost, weight, height, and application effort. All of the power and control components are mounted to the multi-layer PCB substrate with high-yield surface mount technology, resulting in a more reliable product.

DualQor
Dual Output



DQ65033QMA06 Module

Operational Features

- Very high efficiency, >90% at full rated load current
- Delivers up to 60 Watts of output power with minimal derating - no heatsink required
- Wide input voltage range: 35V – 75V, with 100V 100ms input voltage transient capability
- Fixed frequency switching provides predictable EMI performance
- No minimum load requirement means no preload resistors required

Mechanical Features

- Industry standard pin-out configuration
- Industry standard size: 1.45" x 2.3" (36.8x58.4mm)
- Total height less than 0.43" (10.9mm), permits better airflow and smaller card pitch
- Total weight: 1.5 oz. (43 g)
- Flanged pins designed to permit surface mount soldering (avoid wave solder) using FPIP technique

Control Features

- On/Off control referenced to input side (positive and negative logic options are available)
- Output voltage trim: +10%/-10%, permits custom voltages and voltage margining

Protection Features

- Input under-voltage lockout disables converter at low input voltage conditions
- Output current limit and short circuit protection protects converter and load from permanent damage and consequent hazardous conditions
- Active back bias limit prevents damage to converter from external load induced pre-bias
- Output over-voltage protection protects load from damaging voltages
- Thermal shutdown protects converter from abnormal environmental conditions

Safety Features

- 2000V, 30 MΩ input-to-output isolation provides input/output ground separation
- UL/cUL 60950 recognized (US & Canada), basic insulation rating
- TUV certified to EN60950
- Meets 72/23/EEC and 93/68/EEC directives which facilitates CE Marking in user's end product
- Board and plastic components meet UL94V-0 flammability requirements

Input: 35-75V
Outputs: 5.0V & 3.3V
Current: 60W
Package: Quarter-brick

MECHANICAL DIAGRAM

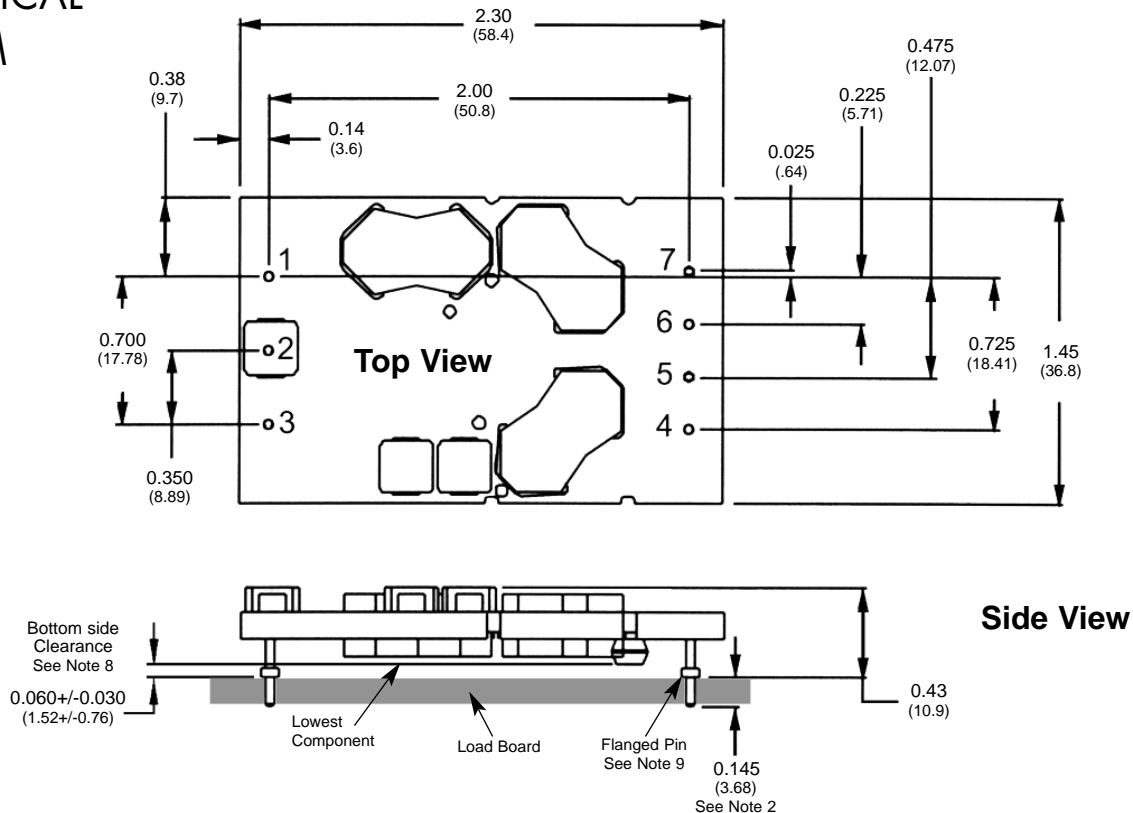

NOTES

- 1) All pins are 0.040" (1.02mm) diameter with 0.080" (2.03 mm) diameter standoff shoulders.
- 2) Other pin extension lengths available. Recommended pin length is 0.03" (0.76mm) greater than the PCB thickness.
- 3) All Pins: Material - Copper Alloy
Finish - Tin/Lead over Nickel plate
- 4) Undimensioned components are shown for visual reference only.
- 5) All dimensions in inches (mm)
Tolerances: x.xx +/-0.02 in. (x.x +/-0.5mm)
x.xxx +/-0.010 in. (x.xx +/-0.25mm)
- 6) Weight: 1.5 oz. (43 g) typical
- 7) Workmanship: Meets or exceeds IPC-A-610C Class II
- 8) UL/TUV standards require a clearance greater than 0.04" (1.02mm) between input and output for Basic insulation. This issue should be considered if any copper traces are on the top side of the user's board. Note that the ferrite cores are considered part of the input/primary circuit.
- 9) The flanged pins are designed to permit surface mount soldering (avoiding the wave soldering process) through the use of the flanged pin-in-paste technique.

PIN DESIGNATIONS

Pin No.	Name	Function
1	Vin(+)	Positive input voltage
2	ON/OFF	TTL input to turn converter on and off, referenced to Vin(-), with internal pull up.
3	Vin(-)	Negative input voltage
4	3.3Vout(+)	3.3V positive output voltage
5	OP RTN	Output Return
6	TRIM	Output voltage trim
7	5.0Vout(+)	5.0V positive output voltage

DQ65033QMA06 ELECTRICAL CHARACTERISTICS

T_A=25°C, airflow rate=300 LFM, V_{in}=48Vdc unless otherwise noted; full operating temperature range is -40°C to +100°C ambient temperature with appropriate power derating. Specifications subject to change without notice.

Parameter	Min.	Typ.	Max.	Units	Notes & Conditions
ABSOLUTE MAXIMUM RATINGS					
Input Voltage					
Non-Operating			100	V	continuous
Operating			80	V	continuous
Operating Transient Protection			100	V	100ms transient, square wave
Isolation Voltage (input to output)			2000	V	Basic insulation, Pollution Degree 2
Operating Temperature	-40		100	°C	
Storage Temperature	-55		125	°C	
Voltage at ON/OFF input pin	-2		18	V	
INPUT CHARACTERISTICS					
Operating Input Voltage Range	35	48	75	V	
Input Under-Voltage Lockout					
Turn-On Voltage Threshold	32	33	34	V	
Turn-Off Voltage Threshold	28.5	29.5	30.5	V	
Lockout Voltage Hysteresis	2.5	3.5	4.5	V	
Maximum Input Current			2.6	A	100% Load, 35 Vin
No-Load Input Current		50		mA	
Disabled Input Current		2.0		mA	
Inrush Current Transient Rating			0.01	A ² s	
Input Reflected Ripple Current			20	mA	p-p thru 10µH inductor; Figures 23 & 25
Input Terminal Ripple Current		175		mA	RMS; Figures 23 & 24
Recommended Input Fuse			20	A	fast blow external fuse recommended
Input Filter Component Values (L\C)	4.7\2.0			µH\µF	internal values, see Figure E
Recommended External Input Capacitance		47		µF	Typical ESR 0.1-0.2Ω, see Figure 23
OUTPUT CHARACTERISTICS					
Output Voltage Set Point (3.3V)		3.28		V	48Vin, 50% load on each voltage
Output Voltage Set Point (5.0V)		4.94		V	48Vin, 50% load on each voltage
Total Output Voltage Regulation (3.3V)	3.2		3.4	V	cross regulation, line, load, temp; Figures 7-10
Total Output Voltage Regulation (5.0V)	4.8		5.2	V	cross regulation, line, load, temp; Figures 7-10
Output Voltage Ripple and Noise (3.3V & 5.0V) ¹					20MHz bandwidth; Figures 23 & 26
Peak-to-Peak		50	100	mV	Full Load, see Figures 23 & 26
RMS		10	20	mV	Full Load, see Figures 23 & 26
Operating Output Current Range (3.3V)	0		18	A	Subject to thermal derating; Figures 11-18
Operating Output Current Range (5.0V)	0		12	A	Subject to thermal derating; Figures 11-18
Output DC Current-Limit Inception (3.3V)		22		A	Output Voltage 10% Low; Figures 27-28
Output DC Current-Limit Inception (5.0V)		14.5		A	Output Voltage 10% Low; Figures 27-28
Short-Circuit Protection - redundant shutdown (3.3V)		40		A	Figures 29-30
Short-Circuit Protection - redundant shutdown (5.0V)		28		A	Figures 29-30
Output DC Current-Limit Shutdown Voltage (3.3\5.0V)		2.0\3.2		V	
Back-Drive Current Limit while Enabled (3.3V only)		0.92		mA	Negative current drawn from output
Back-Drive Current Limit while Disabled (3.3V only)		2	20	mA	Negative current drawn from output
Maximum Output Capacitance (3.3V) - 50/50 split			13,600	µF	60W load; 5% overshoot at Vout at startup
Maximum Output Capacitance (5.0V) - 50/50 split			6,800	µF	60W load; 5% overshoot at Vout at startup
DYNAMIC CHARACTERISTICS					
Input Voltage Ripple Rejection (3.3\5.0V)		80\80		dB	120 Hz; Figures 33-34
Output Voltage during Load Current Transient					
For a Step Change in 3.3V Output Current (.1A/µs)		250		mV	50% to 75% to 50% lout max; Figure 21
For a Step Change in 5.0V Output Current (.1A/µs)		250		mV	50% to 75% to 50% lout max; Figure 22
Settling Time		400		µs	to within 1% Vout nom
Turn-On Transient					
Turn-On Time		4	8	ms	Full load, Vout=90% nom.; Figures 19 & 20
Start-Up Inhibit Time		200		ms	-40°C to +125°C; Figure F
Output Voltage Overshoot		5		%	10mF load capacitance, lout = 0A
EFFICIENCY					
100% Load (40W)		90		%	48Vin, 50% load each Vout; Figures 1 - 6
50% Load (20W)		92		%	48Vin, 25% load each Vout; Figures 1 - 6
TEMPERATURE LIMITS FOR POWER DERATING CURVES					
Semiconductor Junction Temperature			125	°C	Package rated to 150°C
Board Temperature			125	°C	UL rated max operating temp 165°C
Transformer Temperature			110	°C	See Figures 11 - 18 for derating curves
ISOLATION CHARACTERISTICS					
Isolation Voltage (dielectric strength)		2000		V	
Isolation Resistance		30		MΩ	
Isolation Capacitance ²		470		pF	

Note 1: For applications requiring reduced output voltage ripple and noise, consult SynQor applications support (e-mail: support@synqor.com)

Note 2: Higher values of isolation capacitance can be added external to the module.



Technical Specification

Input: 35-75V
Outputs: 5.0V & 3.3V
Current: 60W
Package: Quarter-brick

ELECTRICAL CHARACTERISTICS (Continued)

Parameter	Min.	Typ.	Max.	Units	Notes & Conditions
FEATURE CHARACTERISTICS					
Regulation Stage Switching Frequency	205	215	225	kHz	
Isolation Stage Switching Frequency		108		kHz	
ON/OFF Control (Option P)					
Off-State Voltage	-2		0.8	V	
On-State Voltage	2.4		18	V	
ON/OFF Control (Option N)					
Off-State Voltage	2.4		18	V	
On-State Voltage	-2		0.8	V	
ON/OFF Control (Either Option)					Figures A, B
Pull-Up Voltage		$V_{in}/6$	9.2	V	
Pull-Up Resistance		40		k Ω	
Output Voltage Trim Range	-10		+10	%	Trim-up pins 6-5, Trim-down pins 6-4; Figure C
Output Over-Voltage Protection (3.3V)		4		V	Over full temp range
Output Over-Voltage Protection (5.0V)		6.2		V	Over full temp range
Over-Temperature Shutdown	117	122	127	$^{\circ}$ C	Average PCB Temperature
Over-Temperature Shutdown Restart Hysteresis		10		$^{\circ}$ C	
Load Current Scale Factor (5.0V rail)		231			See App Note: Output Load Current Calc.
RELIABILITY CHARACTERISTICS					
Calculated MTBF (Telcordia)		TBD		10 ⁶ Hrs.	TR-NWT-000332; 80% load, 300LFM, 40 $^{\circ}$ C T _a
Calculated MTBF (MIL-217)		2.5		10 ⁶ Hrs.	MIL-HDBK-217F; 80% load, 300LFM, 40 $^{\circ}$ C T _a
Field Demonstrated MTBF				10 ⁶ Hrs.	See website for latest values

STANDARDS COMPLIANCE

Parameter	Notes
STANDARDS COMPLIANCE	
UL/cUL 60950	File # E194341, Basic insulation & pollution degree 2
EN60950	Certified by TUV
72/23/EEC	
93/68/EEC	
Needle Flame Test (IEC 695-2-2)	test on entire assembly; board & plastic components UL94V-0 compliant
IEC 61000-4-2	ESD test, 8kV - NP, 15kV air - NP (Normal Performance)
GR-1089-CORE	Section 7 - electrical safety, Section 9 - bonding/grounding
Telcordia (Bellcore) GR-513	

- An external input fuse must always be used to meet these safety requirements. Contact SynQor for official safety certificates on new releases or download from the SynQor website.

QUALIFICATION TESTING

Parameter	# Units	Test Conditions
QUALIFICATION TESTING		
Life Test	32	95% rated V_{in} and load, units at derating point, 1000 hours
Vibration	5	10-55Hz sweep, 0.060" total excursion, 1 min./sweep, 120 sweeps for 3 axis
Mechanical Shock	5	100g minimum, 2 drops in x and y axis, 1 drop in z axis
Temperature Cycling	10	-40 $^{\circ}$ C to 100 $^{\circ}$ C, unit temp. ramp 15 $^{\circ}$ C/min., 500 cycles
Power/Thermal Cycling	5	Toperating = min to max, V_{in} = min to max, full load, 100 cycles
Design Marginality	5	Tmin-10 $^{\circ}$ C to Tmax+10 $^{\circ}$ C, 5 $^{\circ}$ C steps, V_{in} = min to max, 0-105% load
Humidity	5	85 $^{\circ}$ C, 85% RH, 1000 hours, 2 minutes on and 6 hours off
Solderability	15 pins	MIL-STD-883, method 2003

- Extensive characterization testing of all SynQor products and manufacturing processes is performed to ensure that we supply robust, reliable product. Contact factory for official product family qualification document.

OPTIONS

SynQor provides various options for Logic Sense, Pin Length and Feature Set for this family of DC/DC converters. Please consult the last page of this specification sheet for information on available options.

PATENTS

SynQor is protected under various patents, including but not limited to U.S. Patent numbers 5,999,417; 6,222,742 B1; 6,594,159 B2; 6,545,890 B2.

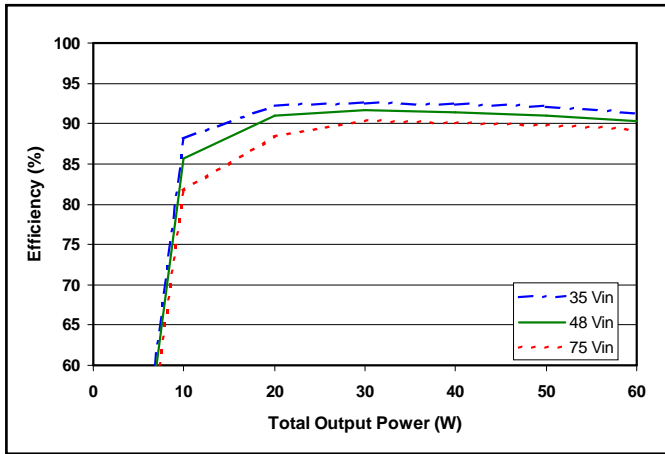

Figure 1: Efficiency vs. output power, from 0 load to full load with 50% load on 3.3V output and 50% load on 5.0V output at minimum, nominal, and maximum input voltage at 25°C.

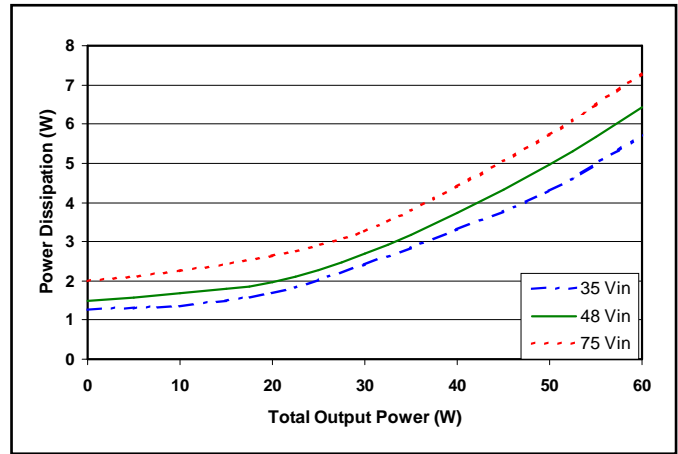

Figure 2: Power dissipation vs. output power, from 0 load to full load with 50% load on 3.3V output and 50% load on 5.0V output at minimum, nominal, and maximum input voltage at 25°C.

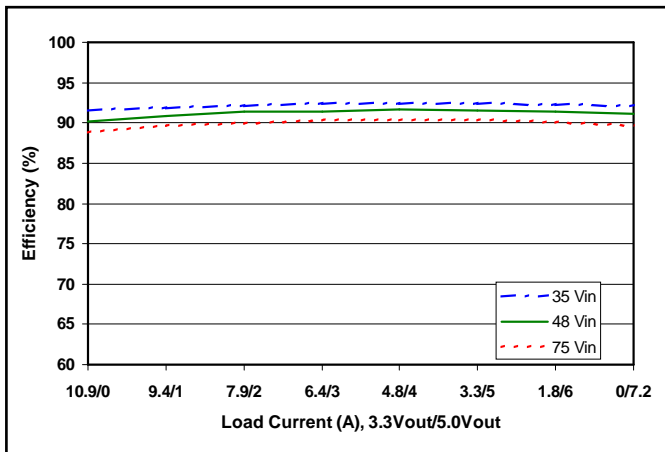

Figure 3: Efficiency vs. load current, with total output power fixed at 60% load (36W) and load currents split as shown between 3.3V and 5.0V outputs at minimum, nominal, and maximum input voltage at 25°C.

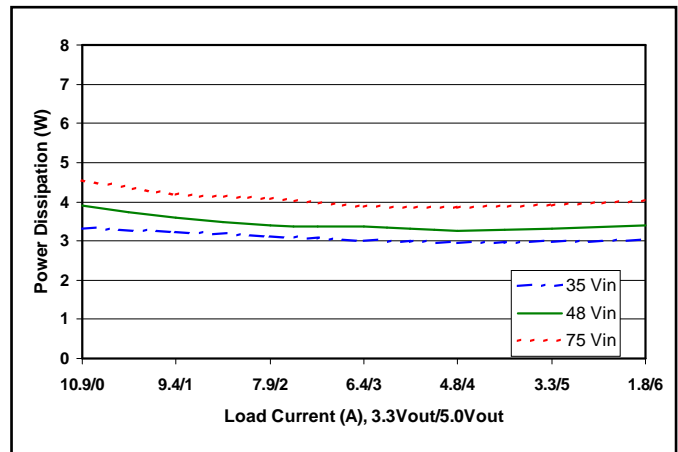

Figure 4: Power dissipation vs. load current, with total output power fixed at 60% load (36W) and load currents split as shown between 3.3V and 5.0V outputs at minimum, nominal, and max input voltage at 25°C.

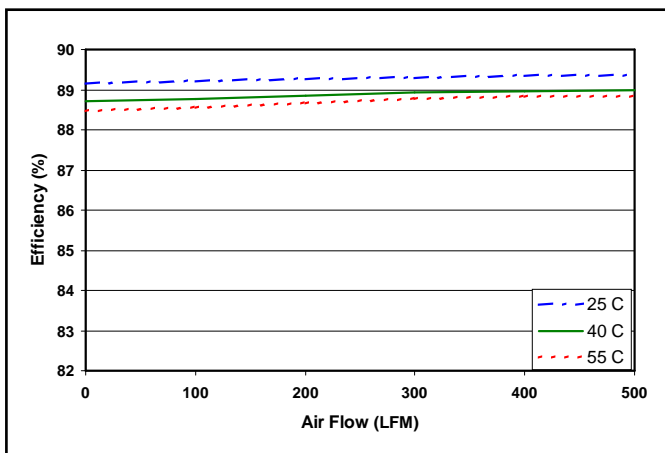

Figure 5: Efficiency at 80% load and 50/50 voltage split (7.3A load on 3.3V and 4.8A load on 5.0V) versus airflow rate for ambient air temperatures of 25°C, 40°C, and 55°C (nominal input voltage).

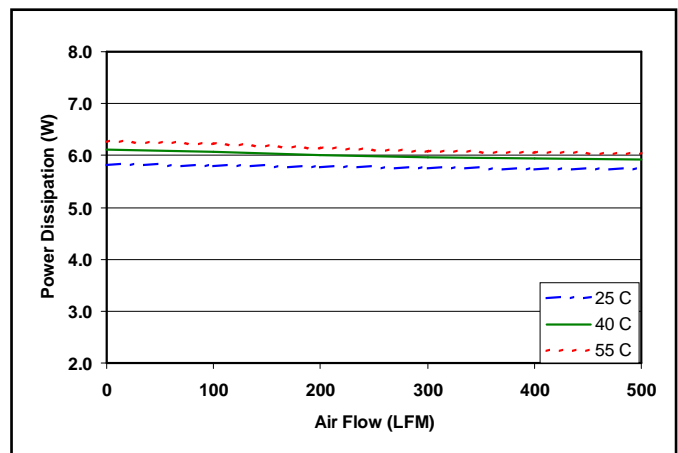

Figure 6: Power dissipation at 80% load and 50/50 voltage split (7.3A load on 3.3V and 4.8A load on 5.0V) versus airflow rate for ambient air temperatures of 25°C, 40°C, and 55°C (nominal input voltage).

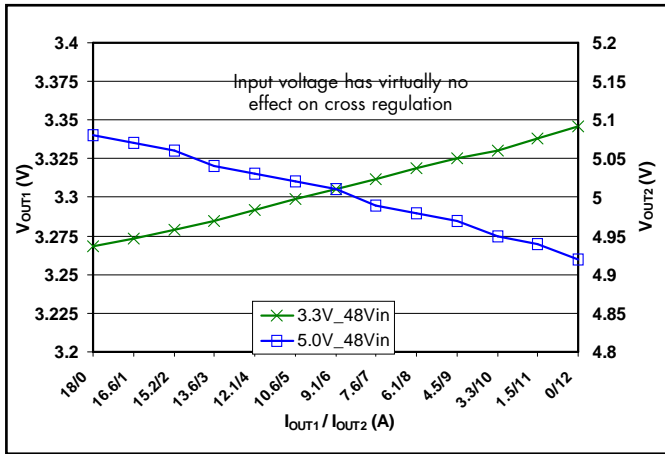

Figure 7: Load regulation vs. load current with power fixed at full load (60W) and load currents split as shown between 3.3V and 5.0V outputs, at nominal input voltage.

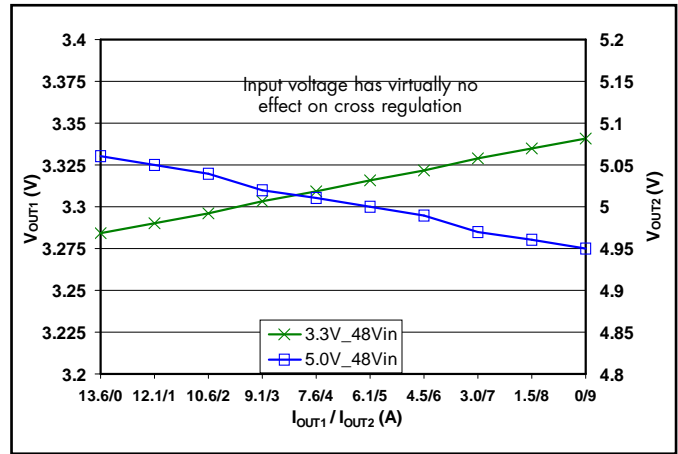

Figure 8: Load regulation vs. load current with power fixed at 75% load (45W) and load currents split as shown between 3.3V and 5.0V outputs, at nominal input voltage.

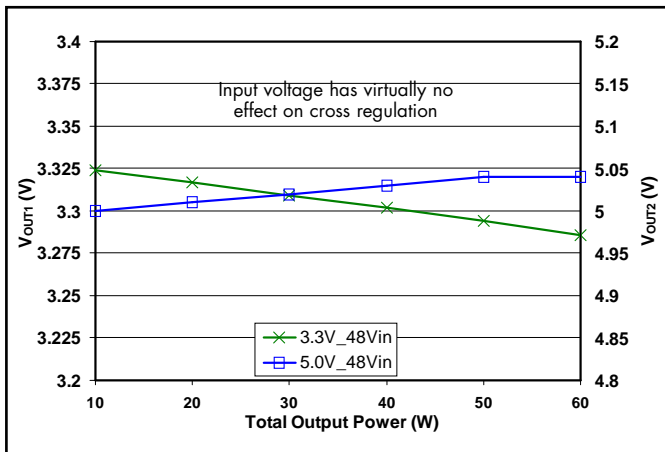

Figure 9: Load regulation vs. output power from 10W load to full load with 75% load on 3.3V output and 25% load on 5.0V output at nominal input voltage.

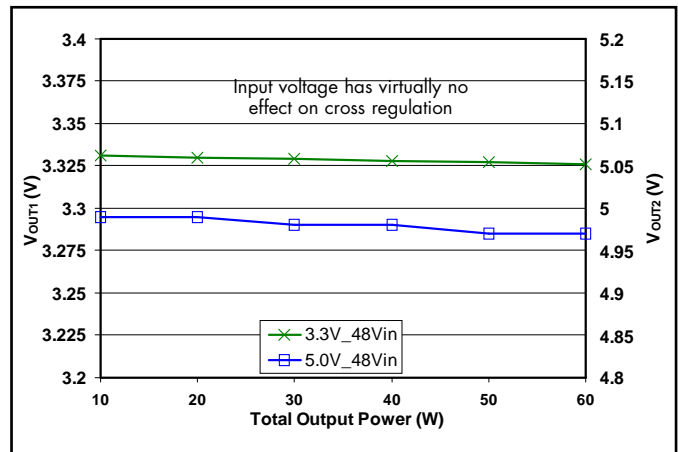

Figure 10: Load regulation vs. output power from 10W load to full load with 25% load on 3.3V output and 75% load on 5.0V output at nominal input voltage.

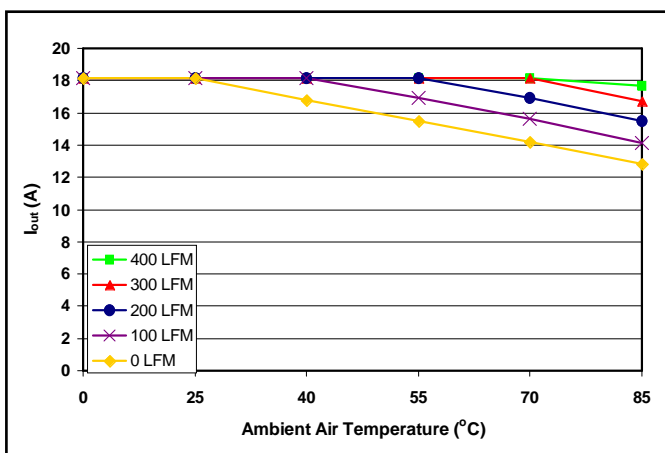

Figure 11: Maximum output power-derating curves vs. ambient air temperature for airflow rates of 0 to 400 LFM, air flowing from pin 1 to pin 3. Full load (18A) on 3.3V output and no load on 5.0V output.

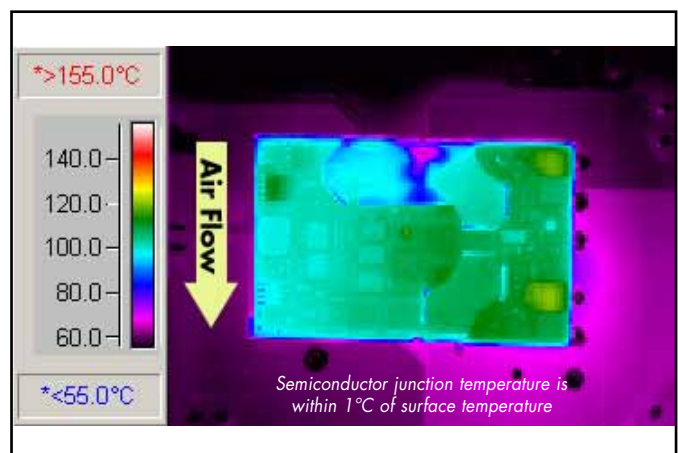

Figure 12: Thermal plot of converter at 18 amp load on 3.3V output and no load on 5.0V output with 55°C air flowing at 200 LFM. Air flow across the converter is from pin 1 to pin 3 (nominal input voltage)

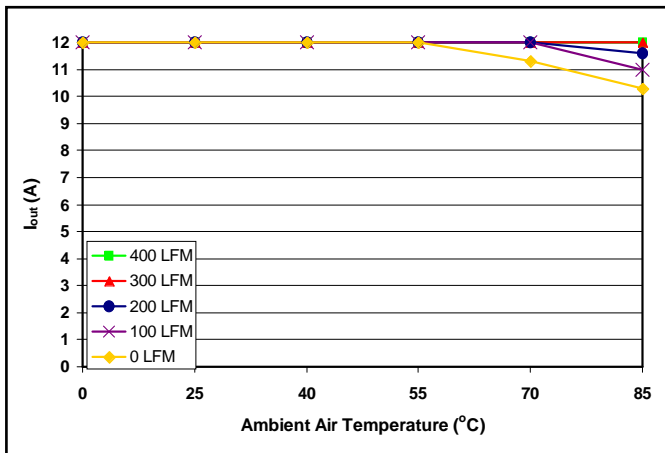

Figure 13: Maximum output power-derating curves vs. ambient air temperature for airflow rates of 0 to 400 LFM, air flowing from pin 1 to pin 3. Full load (12A) on 5.0V output and no load on 3.3V output.

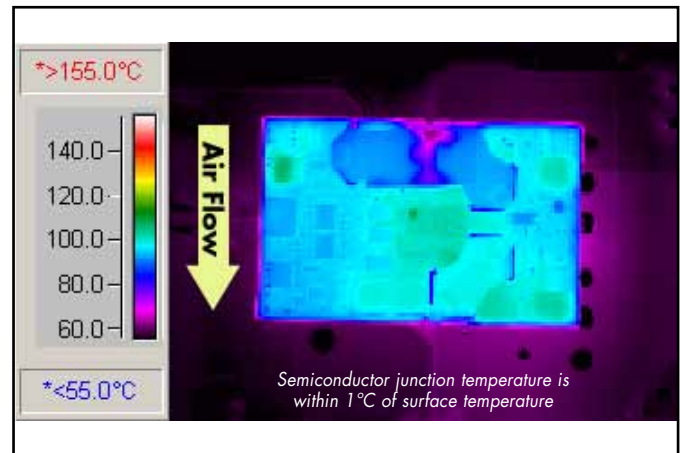

Figure 14: Thermal plot of converter at 12 amp load on 5.0V output and no load on 3.3V output with 55°C air flowing at 200 LFM. Air flow across the converter is from pin 1 to pin 3 (nominal input voltage)

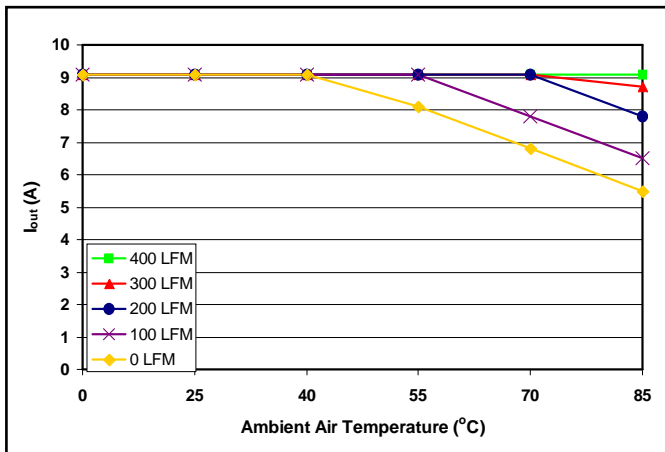

Figure 15: Max output power-derating curves vs. air temp for 0 to 400 LFM, pin 1 to pin 3. 50% load (9A) on 3.3V output and 50% load (6A) on 5.0V output. At derating points, 3.3V output decreases while 5.0V output remains unchanged.

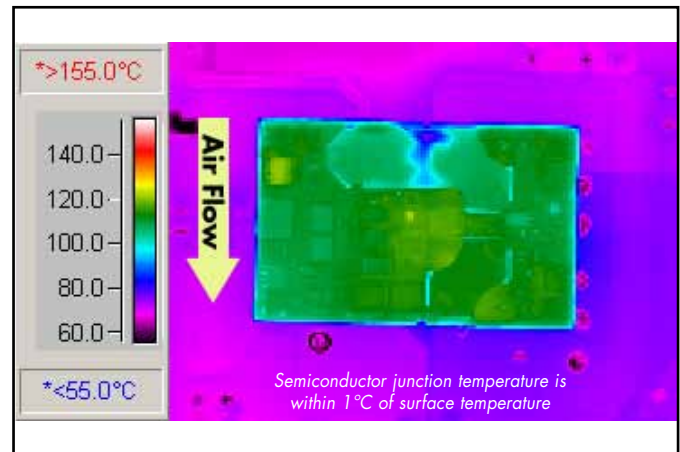

Figure 16: Thermal plot of converter at 9 amp load on 3.3V output and 6 amp load on 5.0V output with 70°C air flowing at 200 LFM. Air flow across the converter is from pin 1 to pin 3 (nominal input voltage)

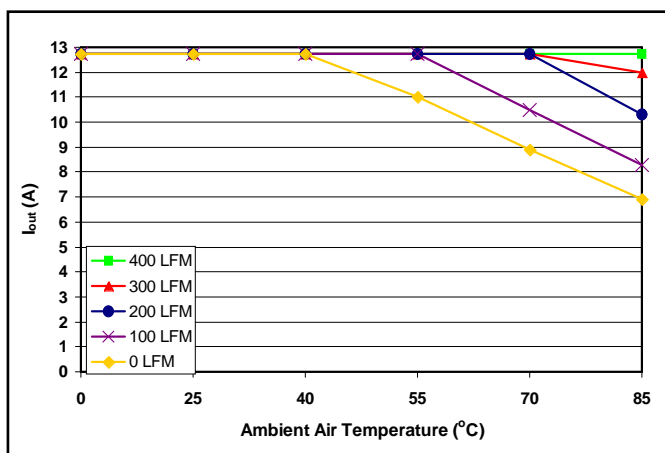

Figure 17: Max output power derating curves vs. air temp for 0 to 400 LFM, pin 1 to pin 3. 70% load (12.7A) on 3.3V output and 30% load (3.6A) on 5.0V output. At derating points, 3.3V output decreases while 5.0V output remains unchanged.

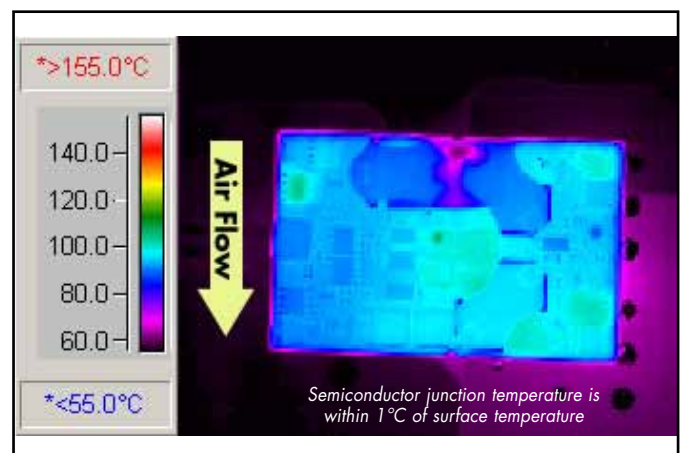

Figure 18: Thermal plot of converter at 12.7 amp load on 3.3V output and 3.6 amp load on 5.0V output with 55°C air flowing at 200 LFM. Air flow across the converter is from pin 1 to pin 3 (nominal input voltage).

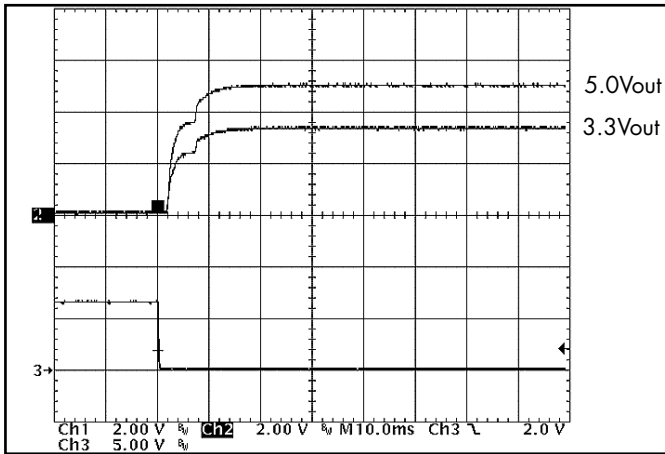

Figure 19: Turn-on transient at full rated load current (resistive load) (10 ms/div). Input voltage pre-applied. Ch 1: 3.3Vout (2V/div); Ch 2: 5.0Vout (2V/div), Ch 3: ON/OFF input (5V/div)

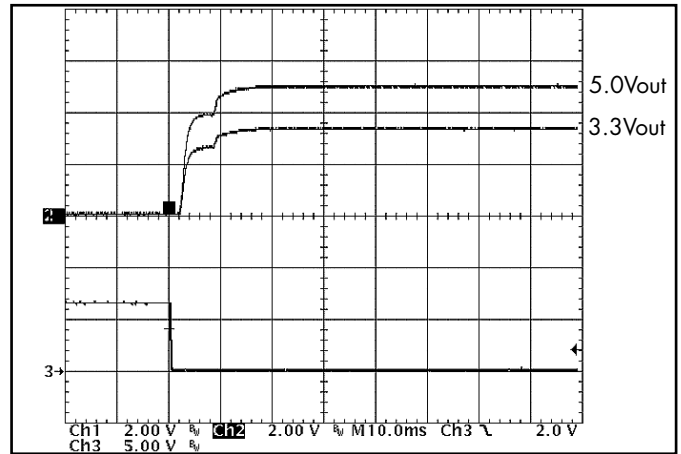

Figure 20: Turn-on transient at zero load current (10 ms/div). Ch 1: 3.3Vout (2V/div); Ch 2: 5.0Vout (2V/div). Ch 3: ON/OFF input (5V/div).

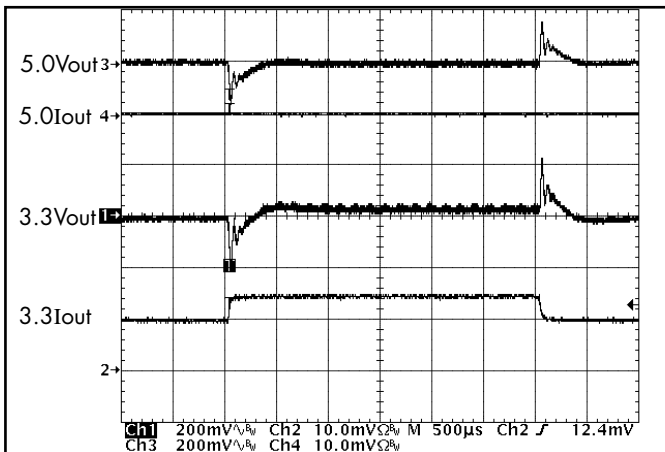

Figure 21: Output voltage response to step-change in Iout1 (50%-75%-50% of Imax; $di/dt = 0.1A/\mu s$). Load cap: 15µF, 300 mΩ ESR tantalum cap & 1µF ceramic cap. Vout (200mV/div), Iout (10A/div). Ch1:Vout1; Ch2:Iout1; Ch3:Vout2; Ch4:Iout2

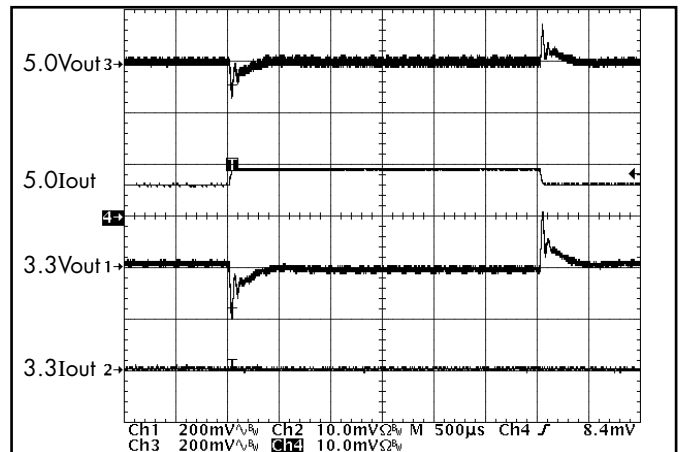

Figure 22: Output voltage response to step-change in Iout2 (50%-75%-50% of Imax; $di/dt = 0.1A/\mu s$). Load cap: 15µF, 300 mΩ ESR tantalum cap & 1µF ceramic cap.. Vout (200mV/div), Iout (10A/div). Ch1:Vout1; Ch2:Iout1; Ch3:Vout2; Ch4:Iout2

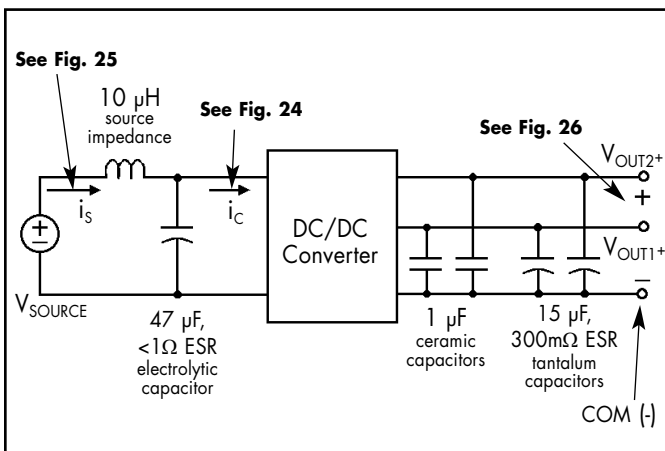

Figure 23: Test set-up diagram showing measurement points for Input Terminal Ripple Current (Figure 24), Input Reflected Ripple Current (Figure 25) and Output Voltage Ripple (Figure 26).

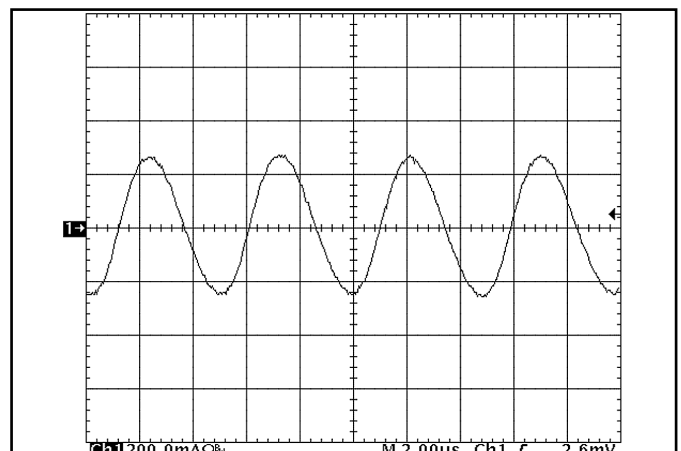

Figure 24: Input Terminal Ripple Current, 3.3V & 5.0V outputs at 50% rated output current and nominal input voltage with 10µH source impedance and 100µF electrolytic capacitor (200 mA/div). (see Fig. 23)

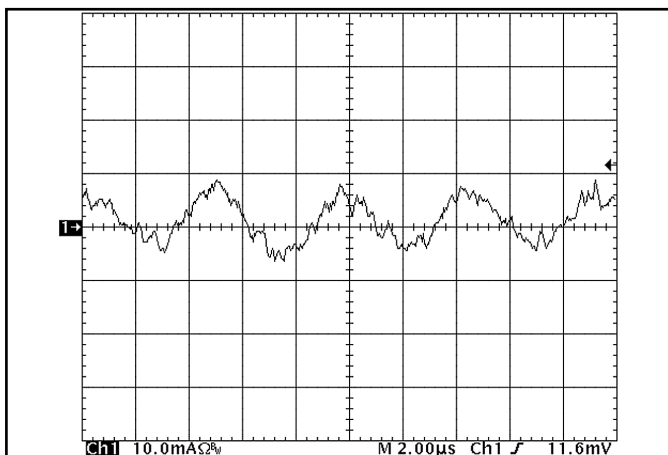

Figure 25: Input reflected ripple current, i_s through a $10\ \mu\text{H}$ source inductor at nominal input voltage and rated load current (5 mA/div). 3.3V and 5.0V outputs at 50% rated load current. (see Fig. 23)

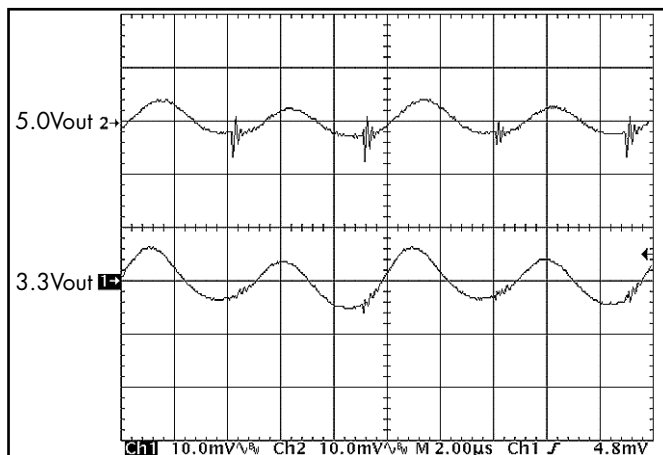

Figure 26: Output voltage ripple at nominal input voltage and 50% rated load current on both outputs (10 mV/div). Load capacitance: $1\ \mu\text{F}$ ceramic cap & $15\ \mu\text{F}$ tantalum cap. Bandwidth: 20 MHz. (see Fig. 23)

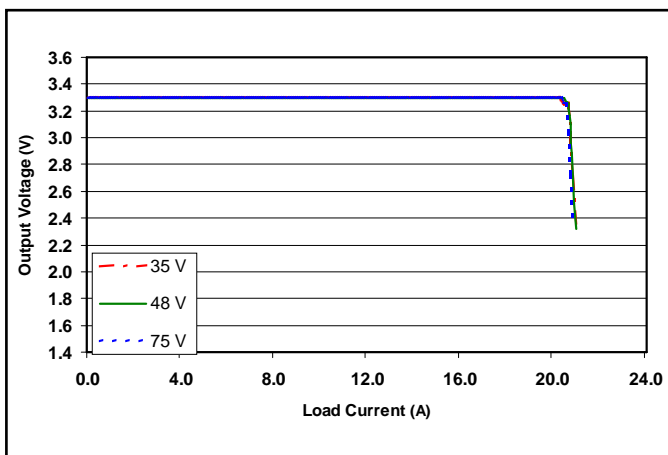

Figure 27: Output voltage vs. load current showing typical current limit curves and converter shutdown points for the 3.3V output. 5.0V load is at 0A.

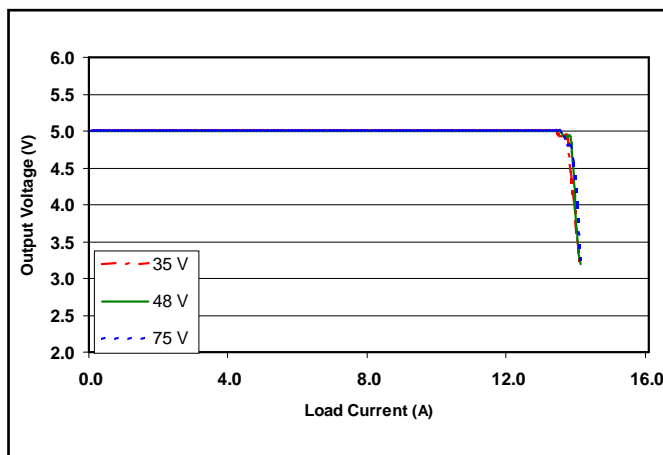

Figure 28: Output voltage vs. load current showing typical current limit curves and converter shutdown points for the 5.0V output. 3.3V load is at 0A.

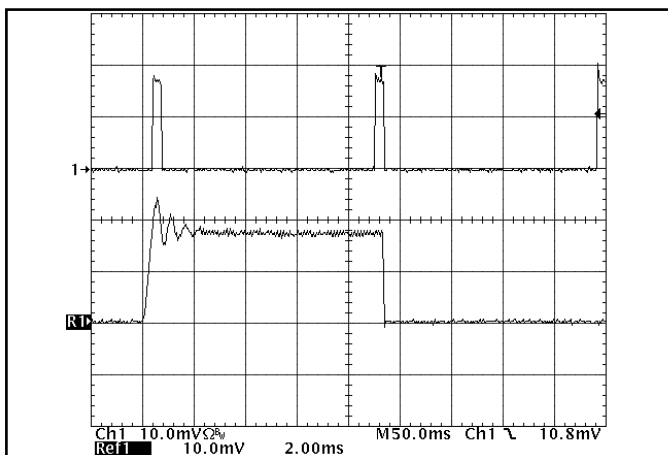

Figure 29: Load current for 3.3V output (10A/div) as a function of time when the converter attempts to turn into a $10\ \text{m}\Omega$ short circuit. Bottom trace is an expansion of the on-time portion of the top trace.

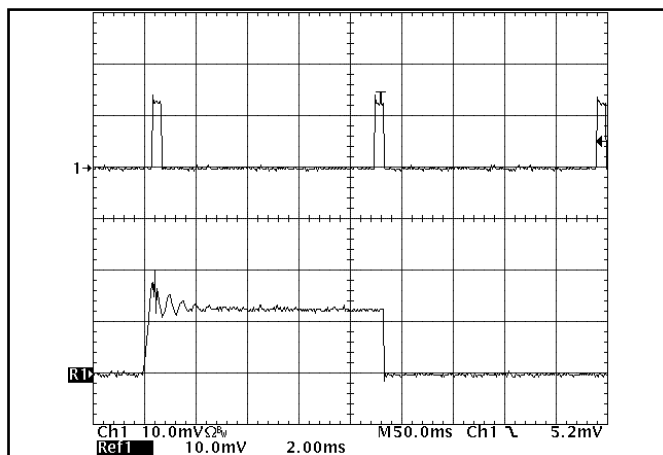

Figure 30: Load current for 5.0V output (10A/div) as a function of time when the converter attempts to turn into a $10\ \text{m}\Omega$ short circuit. Bottom trace is an expansion of the on-time portion of the top trace.

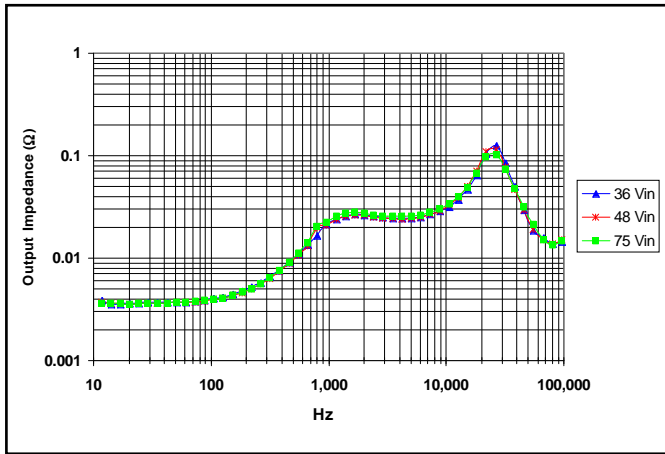

Figure 31: Output impedance ($Z_{out1} = V_{out1}/I_{out1}$) for minimum, nominal, and maximum input voltage at full rated power, for 3.3V output.

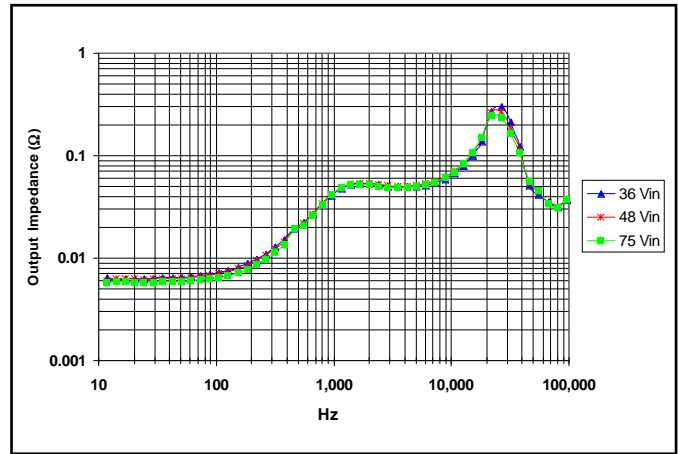

Figure 32: Output impedance ($Z_{out2} = V_{out2}/I_{out2}$) for minimum, nominal, and maximum input voltage at full rated power, for 5.0V output.

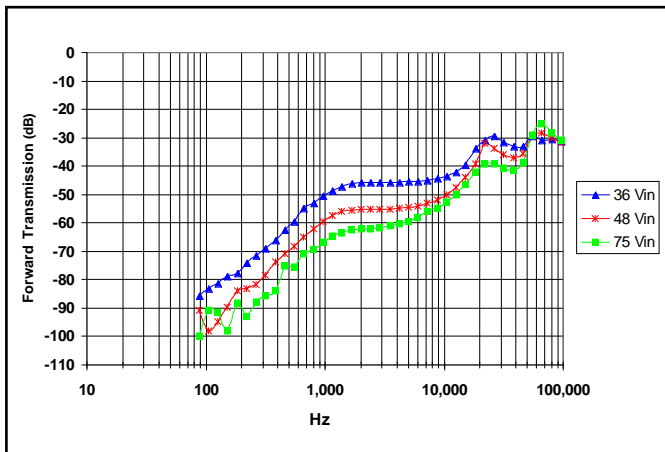

Figure 33: Forward Transmission ($FT_1 = V_{out1}/V_{in}$) for minimum, nominal, and maximum input voltage at full rated power, for 3.3V output.

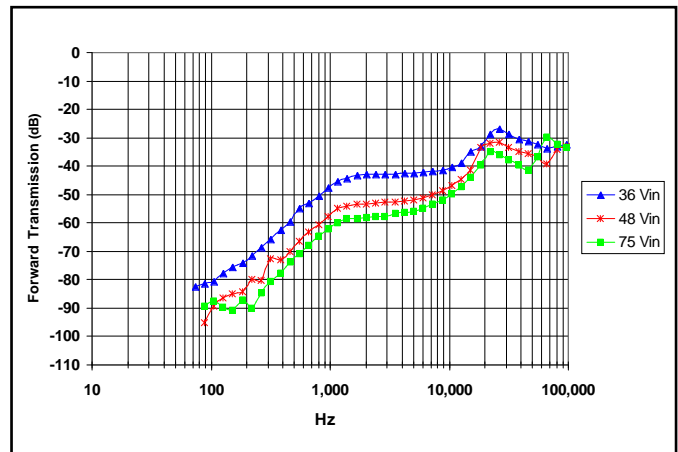

Figure 34: Forward Transmission ($FT_2 = V_{out2}/V_{in}$) for minimum, nominal, and maximum input voltage at full rated power, for 5.0V output.

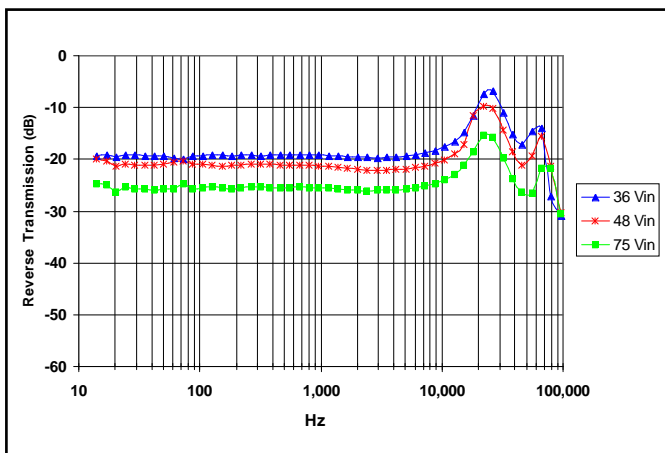

Figure 35: Reverse Transmission ($RT_1 = I_{in}/I_{out1}$) for minimum, nominal, and maximum input voltage at full rated power, for 3.3V output.

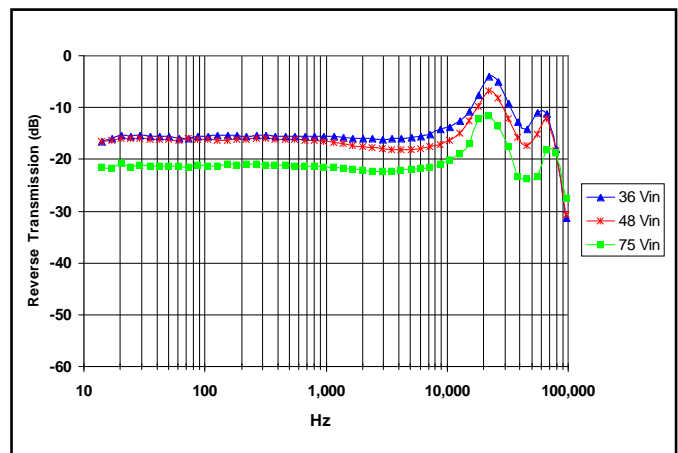

Figure 36: Reverse Transmission ($RT_2 = I_{in}/I_{out2}$) for minimum, nominal, and maximum input voltage at full rated power, for 5.0V output.

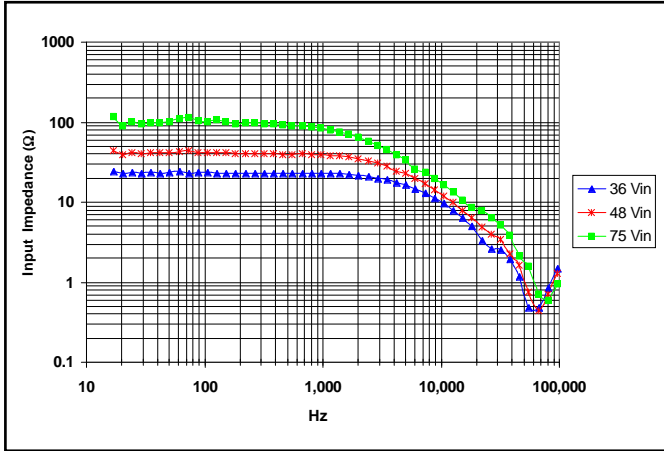

Figure 37: Input impedance ($Z_{in} = V_{in}/I_{in}$) for minimum, nominal, and maximum input voltage at full rated power.

BASIC OPERATION AND FEATURES

The *DualQor* series converter uses a two-stage power conversion topology in which the two output voltages are cross regulated. The first stage is a buck-converter that keeps the output voltage constant over variations in line, load, and temperature. The second stage uses a transformer to provide the functions of input/output isolation and voltage step-down to achieve the low output voltage required.

The two-stage solution is ideal for converters with multiple cross-regulated output voltages. The first-stage compensates for any variations in line voltage. Therefore, the dependence of the output voltage on line variations is minimized.

Both the first stage and the second stage switch at a fixed frequency for predictable EMI performance. Rectification of the transformer's output is accomplished with synchronous rectifiers. These devices, which are MOSFETs with a very low on-state resistance, dissipate far less energy than Schottky diodes. This is the primary reason that the *DualQor* series of converters has such high efficiency, even at very low output voltages and very high output currents.

Dissipation throughout the converter is so low that it does not require a heatsink for operation. However, baseplated versions are available for optional heatsinking in severe thermal environments.

The *DualQor* series converter uses the industry standard footprint and pin-out configuration.

The *DualQor* has many standard control and protection features. All shutdown features are non-latching, meaning that the converter shuts off for 200 ms before restarting. (See Figure F)

CONTROL FEATURES

REMOTE ON/OFF (Pin 2): The ON/OFF input, Pin 2, permits the user to control when the converter is *on* or *off*. This input is referenced to the return terminal of the input bus, $V_{in(-)}$. There are two versions of the converter that differ by the sense of the logic used for the ON/OFF input.

In the positive logic version, the ON/OFF input is active high (meaning that a high turns the converter *on*). In the negative logic version, the ON/OFF signal is active low (meaning that a low turns the converter *on*). Figure A details five possible circuits for driving the ON/OFF pin. Figure B is a detailed look of the internal ON/OFF circuitry.

OUTPUT VOLTAGE TRIM (Pin 6): The TRIM input permits the user to adjust the output voltage up or down according to the trim range specifications. It is important to recognize that adjusting one output will also adjust the second output proportionally. To lower the output voltage, the user should connect a resistor between Pin 6 and Pin 4. To raise the output voltage, the user should connect a resistor between Pin 6 and Pin 5. The following table shows the resistor values needed to trim the output volt-

Vo(%)	1	2	3	4	5	6	7	8	9	10
R_{up}	50	23	14	9.2	6.4	4.5	3.1	2.1	1.3	0
R_{down}	67	30	17	11	7.8	5.4	3.7	2.4	1.4	0

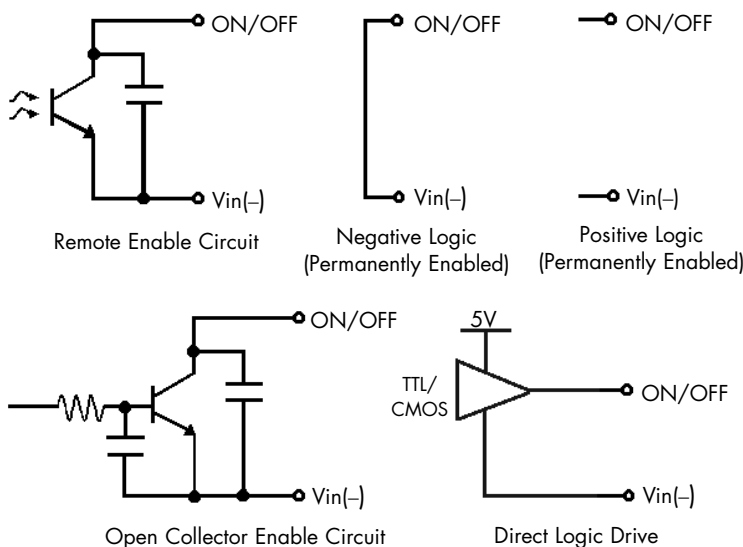

Figure A: Various circuits for driving the ON/OFF pin.

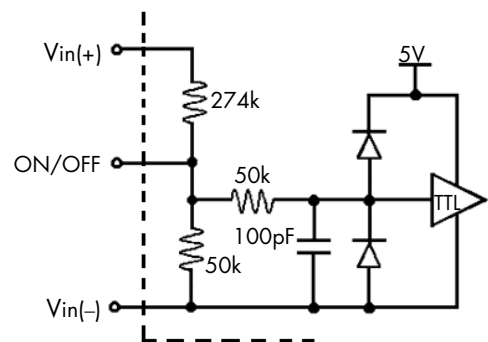

Figure B: Internal ON/OFF pin circuitry

age up or down.

Resistor values in Kohms for the desired increase/decrease (typical) in output voltage (%)

Note: The TRIM feature does not affect the voltage at which the output over-voltage protection circuit is triggered. Trimming the output voltage too high may cause the over-voltage protection circuit to engage, particularly during transients.

Total DC Variation of Vout: For the converter to meet its full specifications, the maximum variation of the DC value of Vout, due to both trimming and remote load voltage drops, should not be greater than that specified for the output voltage trim range.

PROTECTION FEATURES

Input Under-Voltage Lockout: The converter is designed to turn off when the input voltage is too low, helping avoid an input system instability problem, described in more detail in the application note titled "Input System Instability". The lockout circuitry is a comparator with DC hysteresis. When the input voltage is rising, it must exceed the typical Turn-On Voltage Threshold value (listed on the specification page) before the converter will turn on. Once the converter is on, the input voltage must fall below the typical Turn-Off Voltage Threshold value before the converter will turn off.

Output Current Limit: The maximum current limit remains constant as the output voltage drops. However, once the impedance of the short across the output is small enough to make the output voltage drop below the specified Output DC Current-Limit Shutdown Voltage, the converter turns off.

The converter then enters a "hiccup mode" where it repeatedly turns on and off at a 5 Hz (nominal) frequency with a 5% duty

cycle until the short circuit condition is removed. This prevents excessive heating of the converter or the load board.

Output Over-Voltage Limit: If the voltage across the output pins exceeds the Output Over-Voltage Protection threshold, the converter will immediately stop switching. This prevents damage to the load circuit due to 1) excessive series resistance in output current path from converter output pins to sense point, 2) a release of a short-circuit condition, or 3) a release of a current limit condition. Load capacitance determines exactly how high the output voltage will rise in response to these conditions. After 200 ms the converter will automatically restart.

Over-Temperature Shutdown: A temperature sensor on the converter senses the average temperature of the module. The thermal shutdown circuit is designed to turn the converter off when the temperature at the sensed location reaches the Over-Temperature Shutdown value. It will allow the converter to turn on again when the temperature of the sensed location falls by the amount of the Over-Temperature Shutdown Restart Hysteresis value.

APPLICATION CONSIDERATIONS

Input System Instability: This condition can occur because any DC/DC converter appears incrementally as a negative resistance load. A detailed application note titled "Input System Instability" is available on the SynQor web site (www.synqor.com) which provides an understanding of why this instability arises, and shows the preferred solution for correcting it.

Application Circuits: Figure D below provides a typical circuit diagram which details the input filtering and voltage trimming.

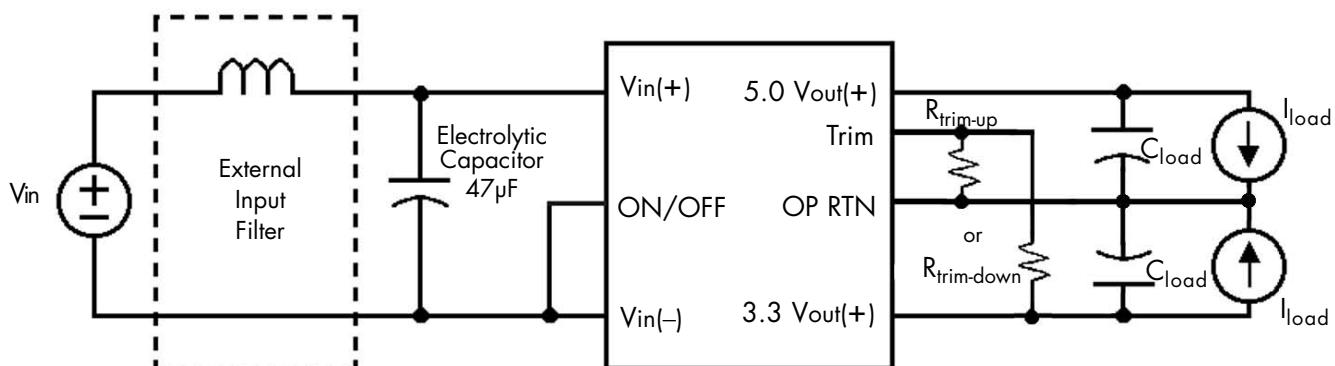

Figure D: Typical application circuit (negative logic unit, permanently enabled).

Input Filtering and External Capacitance: Figure E provides a diagram showing the internal input filter components. This filter dramatically reduces input terminal ripple current, which otherwise could exceed the rating of an external electrolytic input capacitor. The recommended external input capacitance is specified in the "Input Characteristics" section. More detailed information is available in the application note titled "EMI Characteristics" on the SynQor website.

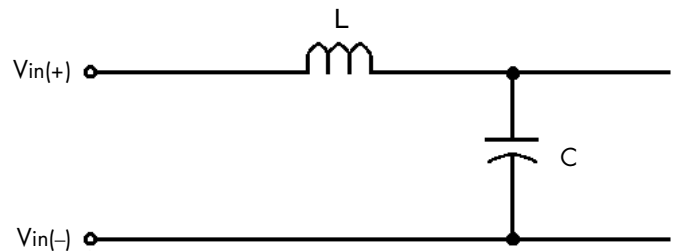

Figure E: Internal Input Filter Diagram (values listed on page 3).

Startup Inhibit Period: The Startup Inhibit Period ensures that the converter will remain off for at least 200ms when it is shut down for any reason. When an output short is present, this generates a 5Hz "hiccup mode," which prevents the converter from overheating. In all, there are seven ways that the converter can be shut down, initiating a Startup Inhibit Period:

- Input Under-Voltage Lockout
- Input Over-Voltage Shutdown (not present in Quarter-brick)
- Output Over-Voltage Protection
- Over Temperature Shutdown
- Current Limit
- Short Circuit Protection
- Turned off by the ON/OFF input

Figure F shows three turn-on scenarios, where a Startup Inhibit Period is initiated at t_0 , t_1 , and t_2 :

Before time t_0 , when the input voltage is below the UVL threshold, the unit is disabled by the Input Under-Voltage Lockout feature. When the input voltage rises above the UVL threshold, the Input Under-Voltage Lockout is released, and a Startup Inhibit Period is initiated. At the end of this delay, the ON/OFF pin is evaluated, and since it is active, the unit turns on.

At time t_1 , the unit is disabled by the ON/OFF pin, and it cannot be enabled again until the Startup Inhibit Period has elapsed.

When the ON/OFF pin goes high after t_2 , the Startup Inhibit Period has elapsed, and the output turns on within the typical Turn-On Time.

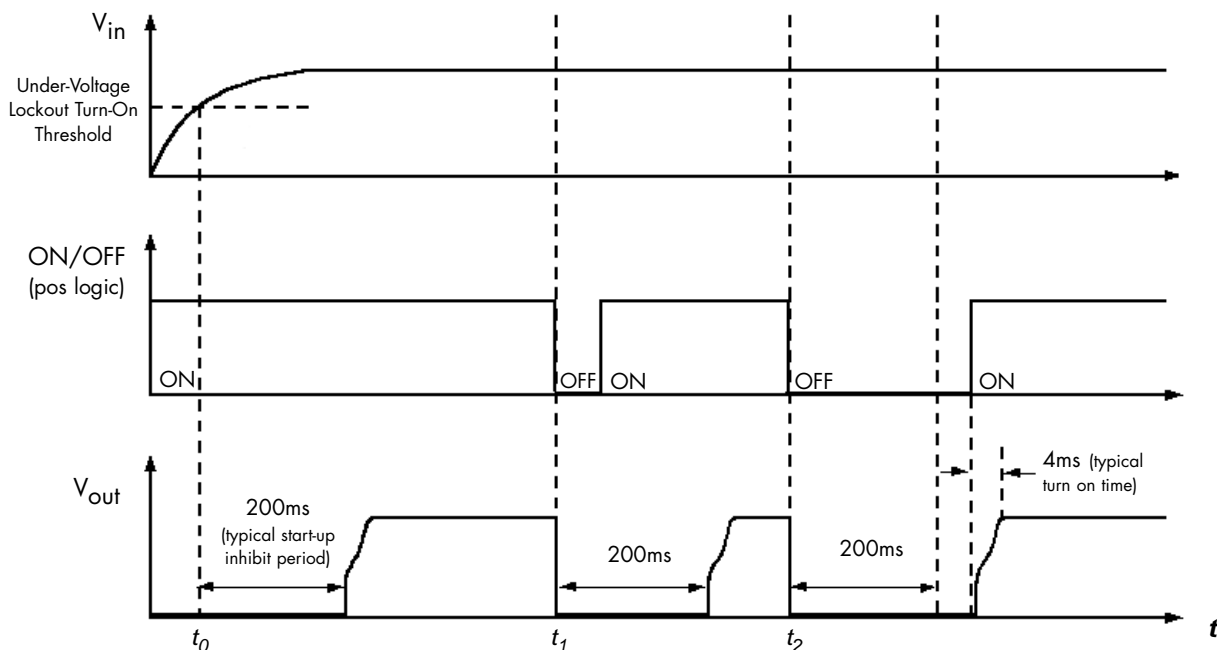

Figure F: Startup Inhibit Period (turn-on time not to scale)



Technical Specification

Input: 35-75V
Outputs: 5.0V & 3.3V
Current: 60W
Package: Quarter-brick

PART NUMBERING SYSTEM

The part numbering system for SynQor's DualQor DC/DC converters follows the format shown in the example below.

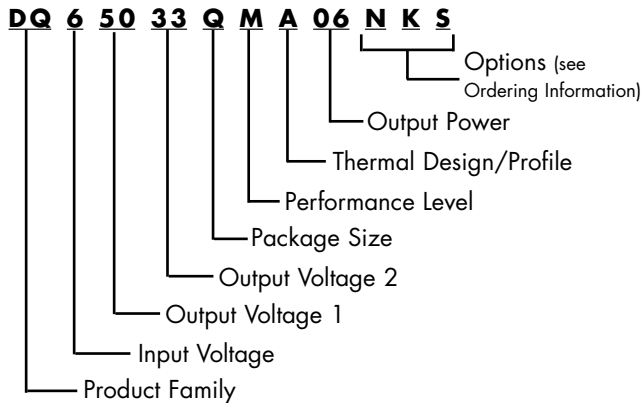

The first 12 characters comprise the base part number and the last 3 characters indicate available options. Although there are no default values for enable logic and pin length, the most common options are negative logic and 0.145" pins. These part numbers are more likely to be readily available in stock for evaluation and prototype quantities.

Application Notes

A variety of application notes and technical white papers can be downloaded in pdf format at www.synqor.com.

Contact SynQor for further information:

Phone: 978-849-0600
Toll Free: 888-567-9596
Fax: 978-849-0602
E-mail: sales@synqor.com
Web: www.synqor.com
Address: 155 Swanson Road
 Boxborough, MA 01719

ORDERING INFORMATION

The tables below show the valid model numbers and ordering options for converters in this product family. When ordering SynQor converters, please ensure that you use the complete 15 character part number consisting of the 12 character base part number and the additional 3 characters for options.

Model Number	Input Voltage	Output Voltages	Max Output Power
DQ63318QMA04xyz	35 - 75 V	3.3/1.8 V	40 W
DQ63325QMA04xyz	35 - 75 V	3.3/2.5 V	40 W
DQ65033QMA06xyz	35 - 75 V	5.0/3.3 V	60 W
DQ61212QMA06xyz	35 - 75 V	+12/-12 V	60 W

The following option choices must be included in place of the x y z spaces in the model numbers listed above.

Options Description: x y z		
Enable Logic	Pin Length	Feature Set
P - Positive N - Negative	K - 0.110" N - 0.145" R - 0.180" Y - 0.250"	S - Standard

Warranty

SynQor offers a three (3) year limited warranty. Complete warranty information is listed on our web site or is available upon request from SynQor.

Information furnished by SynQor is believed to be accurate and reliable. However, no responsibility is assumed by SynQor for its use, nor for any infringements of patents or other rights of third parties which may result from its use. No license is granted by implication or otherwise under any patent or patent rights of SynQor.