

Dual Output, High Efficiency, Isolated DC/DC Converter

The DQ63318QGL08 DualQor™ series is an independently regulated dual output converter that uses the industry standard quarter brick package size. The very high efficiency is a result of SynQor's patented topology that uses synchronous rectification and an innovative construction design to minimize heat dissipation and allow extremely high power densities. The power dissipated by the converter is so low that a heatsink is not required, which saves cost, weight, height, and application effort. All of the power and control components are mounted to the multi-layer PCB substrate with high-yield surface mount technology, resulting in a more reliable product.

DualQor
Dual Output

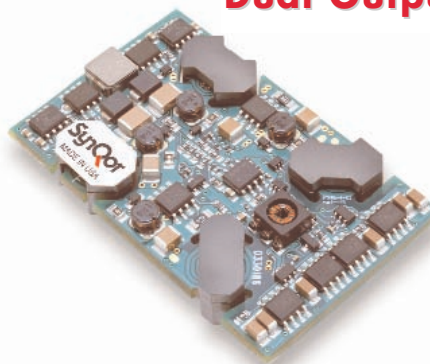

DQ63318QGL08 Module

Operational Features

- Independently regulated outputs (separate control loops)
- High efficiency, >87% at full rated load current
- Delivers up to 77 Watts of output power with minimal derating - no heatsink required
- Wide input voltage range: 35V – 75V, with 100V 100ms input voltage transient withstand
- Fixed frequency switching provides predictable EMI performance
- No minimum load requirement means no preload resistors required

Mechanical Features

- Industry standard pin-out configuration
- Industry standard size: 1.45" x 2.3"
- Low profile of only 0.34", permits better airflow and smaller card pitch
- Total weight: 1.1 oz (31 g), lower mass reduces vibration and shock problems

Control Features

- On/Off control referenced to input side (positive and negative logic options are available)
- Output voltage trim: +10%/-10%, permits custom voltages and voltage margining. Optional second trim pin allows independent trimming.

Protection Features

- Input under-voltage lockout disables converter at low input voltage conditions
- Output current limit and short circuit protection protects converter from excessive load current or short circuits
- Output over-voltage protection protects load from damaging voltages
- Thermal shutdown protects converter from abnormal environmental conditions

Safety Features

- 2000V, 30 MΩ input-to-output isolation provides input/output ground separation
- UL/cUL 60950 recognized (US & Canada), basic insulation rating
- TUV certified to EN60950
- Meets 72/23/EEC and 93/68/EEC directives which facilitates CE Marking in user's end product
- Board and plastic components meet UL94V-0 flammability requirements

MECHANICAL DIAGRAM

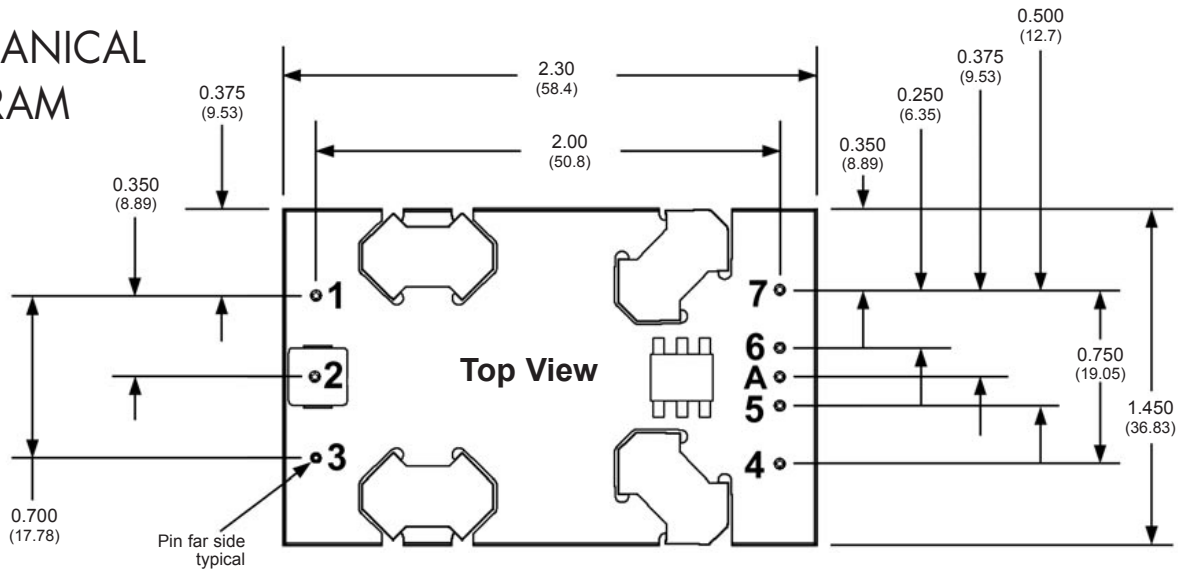

Side View

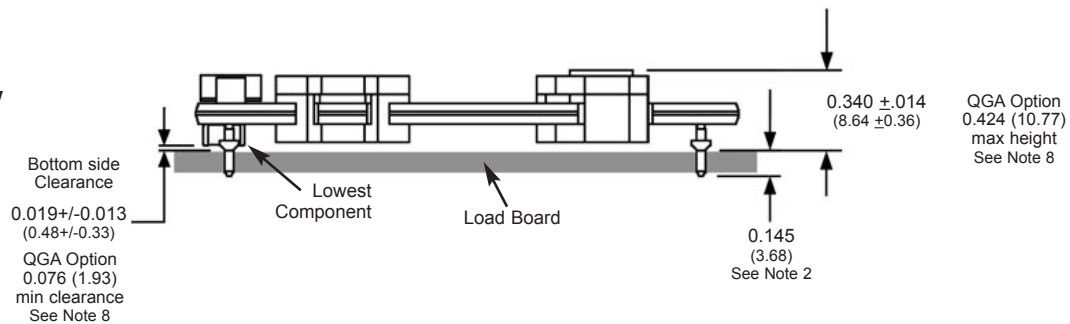

NOTES

- 1) All pins are 0.040" (1.02mm) diameter with 0.080" (2.03 mm) diameter standoff shoulders.
- 2) Other pin extension lengths available. Recommended pin length is 0.03" (0.76mm) greater than the PCB thickness.
- 3) All Pins: Material - Copper Alloy
Finish - Tin/Lead over Nickel plate
- 4) Undimensioned components are shown for visual reference only.
- 5) All dimensions in inches (mm)
Tolerances: x.xx +/-0.02 in. (x.x +/-0.5mm)
x.xxx +/-0.010 in. (x.xx +/-0.25mm)
- 6) Weight: 1.1 oz. (31 g) typical
- 7) Workmanship: Meets or exceeds IPC-A-610C Class II
- 8) Modules can be ordered as QGA option that have different pins to provide a minimum bottom side clearance of 0.076" while increasing maximum height to 0.424". See ordering page for more information.

PIN CONNECTIONS

Pin No.	Name	Function
1	Vin(+)	Positive input voltage
2	ON/OFF	TTL input to turn converter on and off, referenced to Vin(-), with internal pull up.
3	Vin(-)	Negative input voltage
4	1.8Vout(+)	1.8V positive output voltage
5	OP RTN	Output Return
A	<i>2nd TRIM</i>	<i>2nd Output voltage trim²</i>
6	TRIM	Output voltage trim ¹
7	3.3Vout(+)	3.3V positive output voltage

Pins in Italics Shaded text are Optional

NOTES

1. For Standard feature unit (S feature), one trim pin (pin 6) trims both outputs simultaneously by the same amount in the same direction.
2. For units with optional trim pin (T feature), the original trim pin (pin 6) trims the low voltage output and the optional trim pin (pin A) trims the high voltage output. Both trim independently of one other.



Technical Specification

**Quarter
Brick Dual 48V_{in} 3.3/1.8V_{out} 77W**

DQ63318QGL08 ELECTRICAL CHARACTERISTICS

T_A=25°C, airflow rate=300 LFM, V_{in}=48Vdc unless otherwise noted; full operating temperature range is -40°C to +100°C ambient temperature with appropriate power derating. Specifications subject to change without notice.

Parameter	Min.	Typ.	Max.	Units	Notes & Conditions
ABSOLUTE MAXIMUM RATINGS					
Input Voltage					
Non-Operating			100	V	continuous
Operating			80	V	continuous
Operating Transient Protection			100	V	100ms transient
Isolation Voltage (input to output)			2000	V	Basic level, Pollution Degree 2
Operating Temperature	-40		100	°C	
Storage Temperature	-55		125	°C	
Voltage at ON/OFF input pin	-2		18	V	
INPUT CHARACTERISTICS					
Operating Input Voltage Range	35	48	75	V	
Input Under-Voltage Lockout					
Turn-On Voltage Threshold	32	33	34	V	
Turn-Off Voltage Threshold	28.5	29.5	30.5	V	
Lockout Hysteresis Voltage	2.5	3.5	4.5	V	
Maximum Input Current			3	A	100% Load, 35 V _{in}
No-Load Input Current		60	80	mA	
Disabled Input Current		2	3	mA	
Inrush Current Transient Rating			0.03	A ² s	
Response to Input Transient			5	mV	1000V/ms input transient
Input Reflected-Ripple Current		3		mA	RMS thru 10µH inductor; Figs. 17 & 19
Recommended Input Fuse			20	A	fast blow external fuse recommended
Input Filter Component Values (L\C)		4.7\1x2		µH\µF	internal values, see Figure E
Recommended External Input Capacitance	33	47		µF	see Figure 17
OUTPUT CHARACTERISTICS					
Output Voltage Set Point (1.8V)	1.76	1.80	1.84	V	48V _{in} , 50% load on each voltage
Output Voltage Set Point (3.3V)	3.26	3.30	3.34	V	48V _{in} , 50% load on each voltage
Output Voltage Regulation (1.8V)					
Over Line		±0.05 \ 2	±0.15 \ 5	%\mV	
Over Load		±0.8 \ 15	±1.7 \ 30	%\mV	
Over Temperature		±30	±50	mV	
Total Output Voltage Regulation (3.3V)					
Over Line		±0.05 \ 2	±0.15 \ 5	%\mV	
Over Load		±0.5 \ 17	±1.0 \ 33	%\mV	
Over Temperature		±50	±70	mV	
Total Output Voltage Range (1.8V)	1.72		1.88	V	over sample, line, load, temperature & life
Total Output Voltage Range (3.3V)	3.19		3.41	V	over sample, line, load, temperature & life
Output Voltage Ripple and Noise (1.8V & 3.3V)					20MHz bandwidth; Fig. 17 & 20
Peak-to-Peak		50	100	mV	Full Load, see Figures 17 & 20
RMS		10	20	mV	Full Load, see Figures 17 & 2
Operating Output Current Range (1.8V)	0		15	A	
Operating Output Current Range (3.3V)	0		15	A	
Output DC Current-Limit Inception (1.8V)	15.2	17	19.4	A	Output Voltage 10% Low; Figs. 21-22
Output DC Current-Limit Inception (3.3V)	15.2	17	19.4	A	Output Voltage 10% Low; Figs. 21-22
Short-Circuit Protection - redundant shutdown (1.8V)		17		A	Figures 23-24
Short-Circuit Protection - redundant shutdown (3.3V)		17		A	Figures 23-24
Output DC Current-Limit Shutdown Voltage (1.8V)		0.6		V	
Output DC Current-Limit Shutdown Voltage (3.3V)		1.0		V	
Back-Drive Current Limit while Enabled		10		mA	Negative current drawn from output
Back-Drive Current Limit while Disabled		10		mA	Negative current drawn from output
Maximum Output Capacitance (1.8V)			10	mF	1.8V at 15A resistive load
Maximum Output Capacitance (3.3V)			10	mF	3.3V at 15A resistive load
DYNAMIC CHARACTERISTICS					
Input Voltage Ripple Rejection (1.8V \ 3.3V)		80\80		dB	120 Hz; Figs. 27-28
Output Voltage during Load Current Transient					
Step Change in 1.8V Output Current (.1A/µs)		100		mV	50% to 75% to 50% lout max; Figure 15
Step Change in 3.3V Output Current (.1A/µs)		100		mV	50% to 75% to 50% lout max; Figure 16
Settling Time		300		µs	to within 1% V _{out} nom
Turn-On Transient					
Turn-On Time		6	12	ms	Full load, V _{out} =90% nom.; Figs. 13 & 14
Start-Up Inhibit Time	180	200	215	ms	-40°C to +125°C; Figure F
Output Voltage Overshoot		0		%	10mF load capacitance, lout = 0A
EFFICIENCY					
100% Load		87.5		%	48V _{in} , 100% load each V _{out} ; Figs 1 - 6
50% Load		87.5		%	48V _{in} , 50% load each V _{out} ; Figs 1 - 6
TEMPERATURE LIMITS FOR POWER DERATING CURVES					
Semiconductor Junction Temperature			125	°C	Package rated to 150°C
Board Temperature			125	°C	UL rated max operating temp 130°C
Transformer Temperature			125	°C	See Figures 7 - 12 for derating curves



Technical Specification

**Quarter
Brick Dual 48V_{in} 3.3/1.8V_{out} 77W**

ELECTRICAL CHARACTERISTICS (Continued)

Parameter	Min.	Typ.	Max.	Units	Notes & Conditions
ISOLATION CHARACTERISTICS					
Isolation Voltage		2000		V	
Isolation Resistance		30		MΩ	
Isolation Capacitance		3300		pF	
FEATURE CHARACTERISTICS					
Switching Frequency	230	260	290	kHz	
ON/OFF Control (Option P)					
Off-State Voltage	-2		0.8	V	
On-State Voltage	2.4		18	V	
ON/OFF Control (Option N)					
Off-State Voltage	2.4		18	V	
On-State Voltage	-2		0.8	V	
ON/OFF Control (Either Option)					Figures A, B
Pull-Up Voltage		V _{in} /6.5	9.2	V	
Pull-Up Resistance		40		kΩ	
Output Voltage Trim Range	-10		+10	%	Trim-up pins 6-5, Trim-down pins 6-4; Fig D
Output Over-Voltage Protection (1.8V)	111	117	125	%	Over full temp range
Output Over-Voltage Protection (3.3V)	111	117	125	%	Over full temp range
Over-Temperature Shutdown		125		°C	Average PCB Temperature
Over-Temperature Shutdown Restart Hysteresis		10		°C	
RELIABILITY CHARACTERISTICS					
Calculated MTBF (Telcordia)		TBD		10 ⁶ Hrs.	TR-NWT-000332; 80% load, 300LFM, 40°C T _a
Calculated MTBF (MIL-217)		TBD		10 ⁶ Hrs.	MIL-HDBK-217F; 80% load, 300LFM, 40°C T _a
Demonstrated MTBF		TBD		10 ⁶ Hrs.	Field demonstrated MTBF

STANDARDS COMPLIANCE

Parameter	Notes
STANDARDS COMPLIANCE	
UL/cUL 60950	File # E194341, Basic insulation & pollution degree 2
EN60950	Certified by TÜV
72/23/EEC	
93/68/EEC	
Needle Flame Test (IEC 695-2-2)	test on entire assembly; board & plastic components UL94V-0 compliant
IEC 61000-4-2	ESD test, 8kV - NP, 15kV air - NP
GR-1089-CORE	Section 7 - electrical safety, Section 9 - bonding/grounding
Telcordia (Bellcore) GR-513	

- An external input fuse must always be used to meet these safety requirements

QUALIFICATION TESTING

Parameter	# Units	Test Conditions
QUALIFICATION TESTING		
Life Test	32	95% rated V _{in} and load, units at derating point, 1000 hours
Vibration	5	10-55Hz sweep, 0.060" total excursion, 1 min./sweep, 120 sweeps for 3 axis
Mechanical Shock	5	100g minimum, 2 drops in x and y axis, 1 drop in z axis
Temperature Cycling	10	-40°C to 100°C, unit temp. ramp 15°C/min., 500 cycles
Power/Thermal Cycling	5	T _{operating} = min to max, V _{in} = min to max, full load, 100 cycles
Design Marginality	5	T _{min} -10°C to T _{max} +10°C, 5°C steps, V _{in} = min to max, 0-105% load
Humidity	5	85°C, 85% RH, 1000 hours, 2 minutes on and 6 hours off
Solderability	15 pins	MIL-STD-883, method 2003

- Extensive characterization testing of all SynQor products and manufacturing processes is performed to ensure that we supply robust, reliable product. Contact factory for more information about Proof of Design and Proof of Manufacturing processes.

OPTIONS

SynQor provides various options for Logic Sense, Pin Length and Feature Set for this family of DC/DC converters. Please consult the last page of this specification sheet for information on available options.

PATENTS

SynQor is protected under various patents, including but not limited to U.S. Patent # 5,999,417.

Performance Curves

Quarter Brick Dual 48V_{in} 3.3/1.8V_{out} 77W

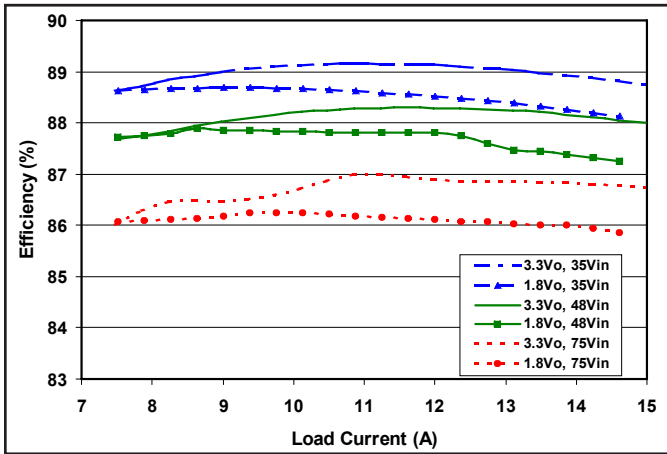

Figure 1: Efficiency vs. output current, from half load to full load on each output voltage at minimum, nominal, and maximum input voltage at 25°C. Output not under test is held constant at half load.

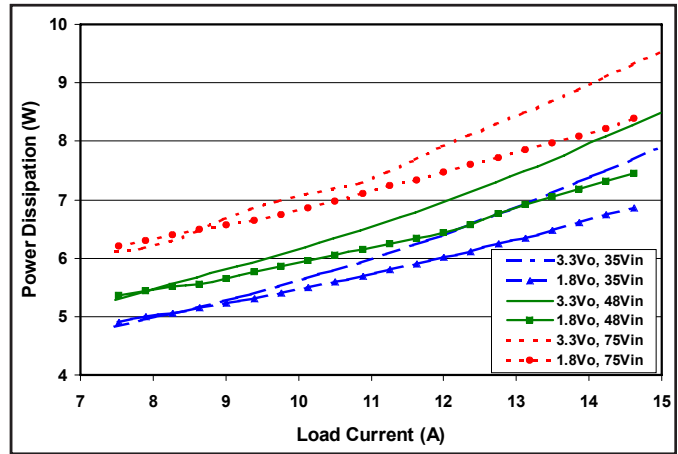

Figure 2: Power dissipation vs. output current, from half load to full load on each output voltage at minimum, nominal, and maximum input voltage at 25°C. Output not under test is held constant at half load.

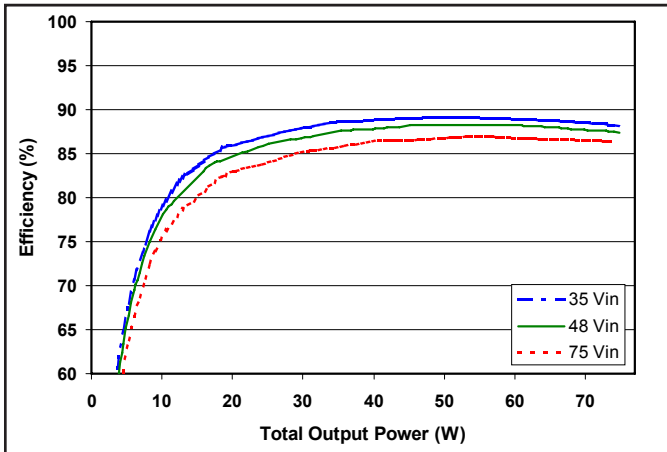

Figure 3: Overall converter efficiency vs. output power from zero load to full load at minimum, nominal, and maximum input voltage at 25°C. Both loads are equal and range from zero to full load.

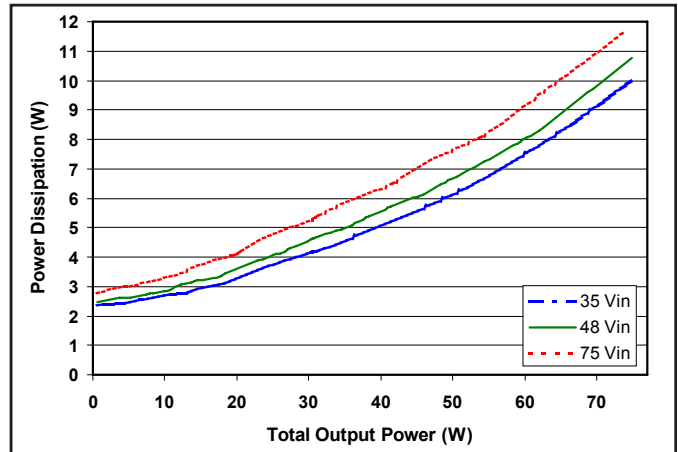

Figure 4: Overall converter power dissipation vs. output power from zero load to full load at minimum, nominal, and maximum input voltage at 25°C. Both loads are equal and range from zero to full load.

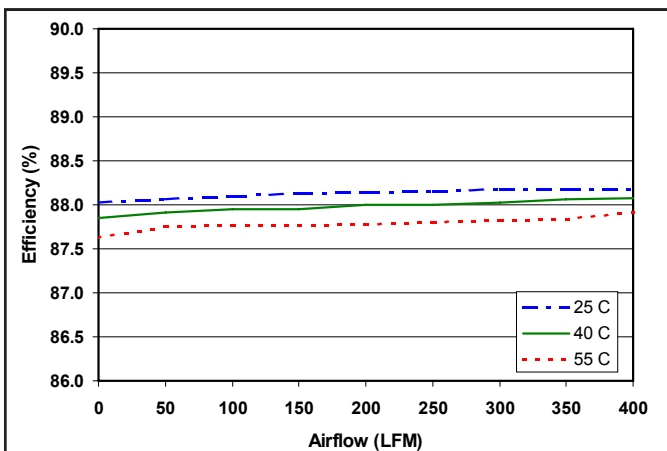

Figure 5: Overall converter efficiency at nominal output voltages and 60% rated power on each output rail vs. airflow rate for ambient temperatures of 25°C, 40°C and 55°C (nominal input voltage).

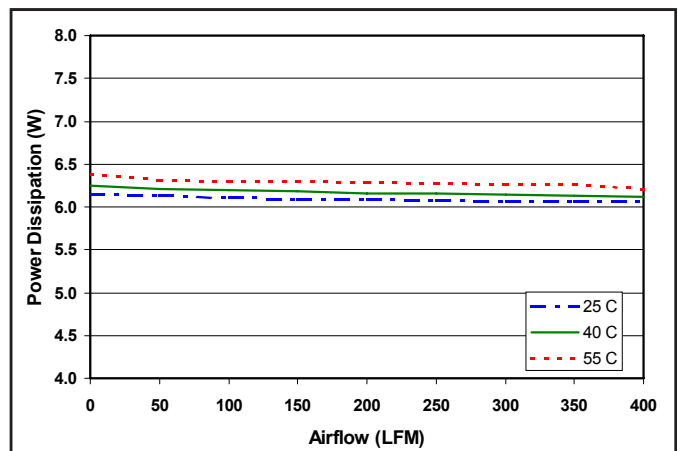

Figure 6: Overall converter power dissipation at nominal output voltages and 60% rated power on each output rail vs. airflow rate for ambient temperatures of 25°C, 40°C and 55°C (nominal input voltage).

Performance Curves

Quarter Brick Dual **48V_{in}** **3.3/1.8V_{out}** **77W**

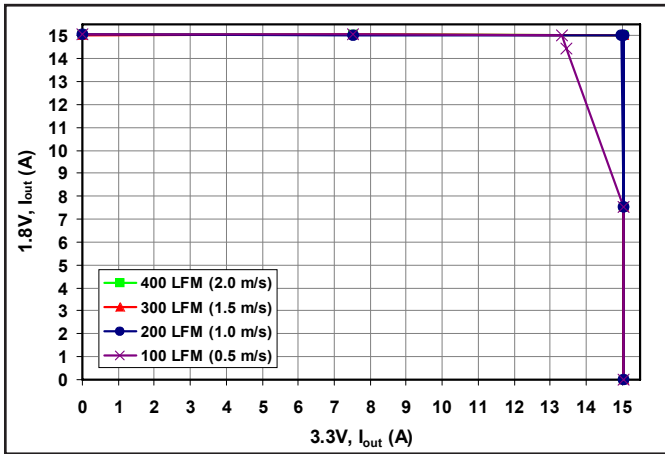

Figure 7: Maximum output power derating curves at 55°C vs. airflow rates of 100 through 400 LFM. Curve shows available current for 1.8V rail on y axis and available current for 3.3V rail on x axis. (nom. Vin)

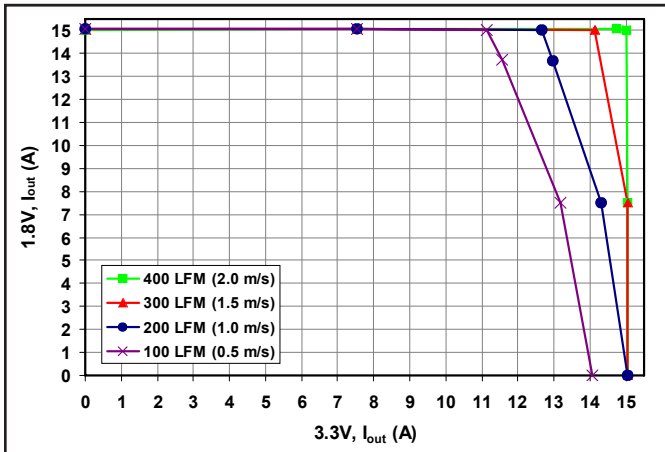

Figure 9: Maximum output power derating curves at 70°C vs. airflow rates of 100 through 400 LFM. Curve shows available current for 1.8V rail on y axis and available current for 3.3V rail on x axis. (nom. Vin)

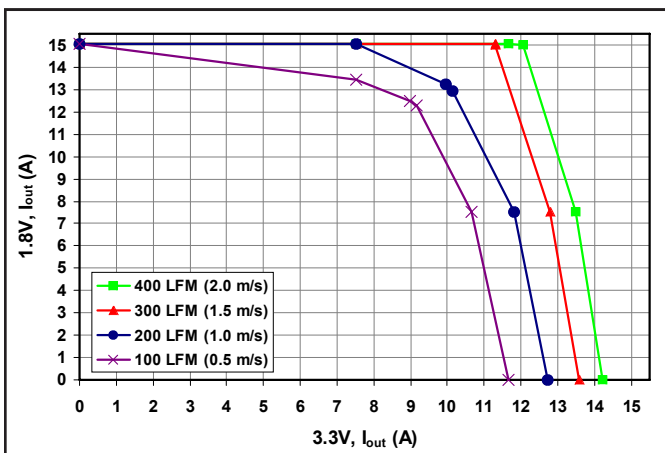

Figure 11: Maximum output power derating curves at 85°C vs. airflow rates of 100 through 400 LFM. Curve shows available current for 1.8V rail on y axis and available current for 3.3V rail on x axis. (nom. Vin)

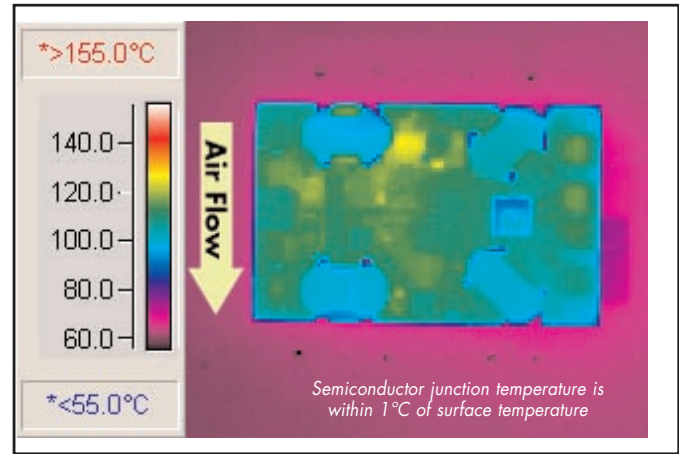

Figure 8: Thermal plot of converter at 15A load on 1.8V output and 15A load on 3.3V output with 55°C air flowing at 200 LFM. Air flow across the converter is from pin 1 to pin 3 (nominal input voltage).

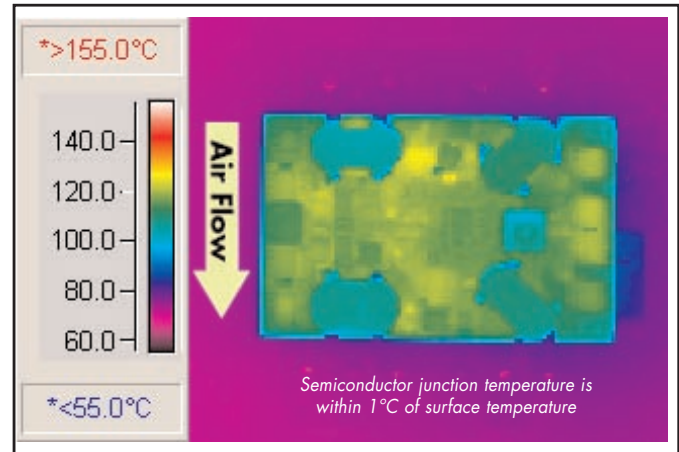

Figure 10: Thermal plot of converter at 15A load on 1.8V output and 12.5A load on 3.3V output with 70°C air flowing at 200 LFM. Air flow across the converter is from pin 1 to pin 3 (nominal input voltage).

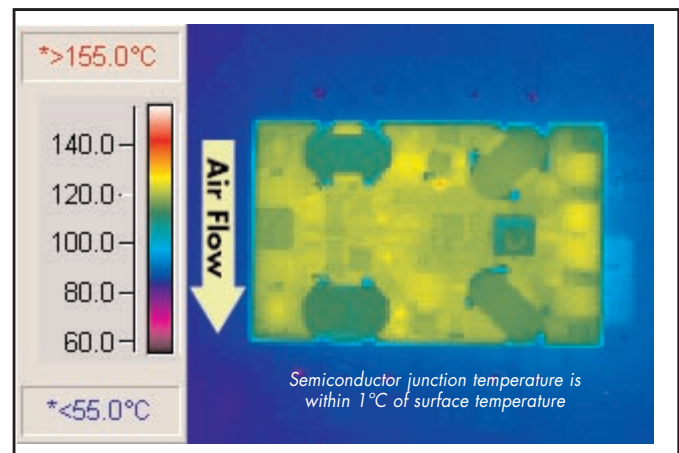

Figure 12: Thermal plot of converter at 13A load on 1.8V output and 10A load on 3.3V output with 85°C air flowing at 200 LFM. Air flow across the converter is from pin 1 to pin 3 (nominal input voltage).

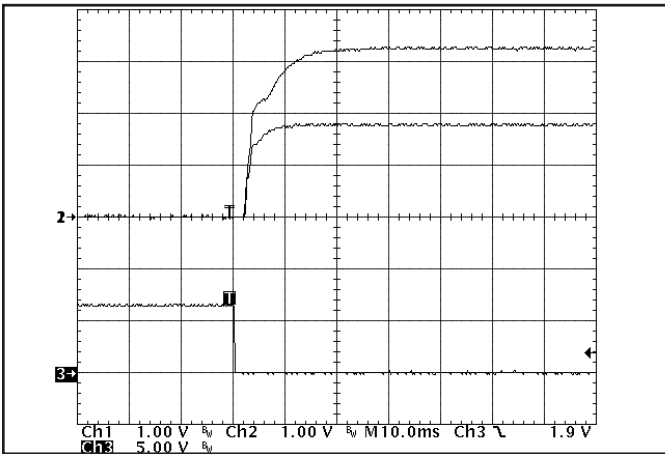

Figure 13: Turn-on transient at full rated load current (resistive load) (10 ms/div). Ch 1: 1.8Vout (1V/div); Ch 2: 3.3Vout (1V/div) Ch 3: ON/OFF input (5V/div)

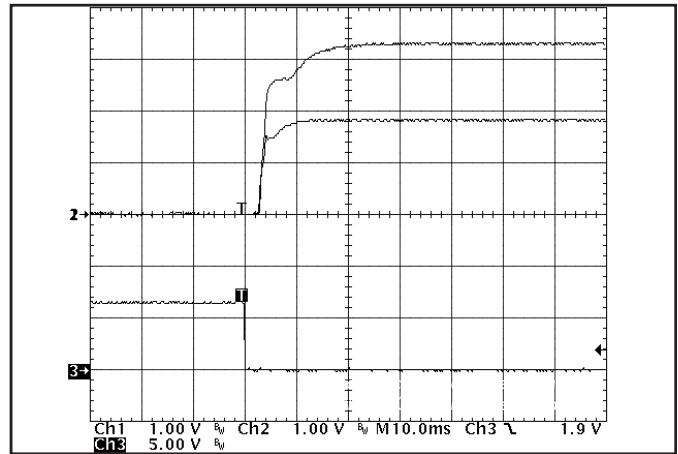

Figure 14: Turn-on transient at zero load current (10 ms/div). Ch 1: 1.8Vout (1V/div); Ch 2: 3.3Vout (1V/div) Ch 3: ON/OFF input (5V/div)

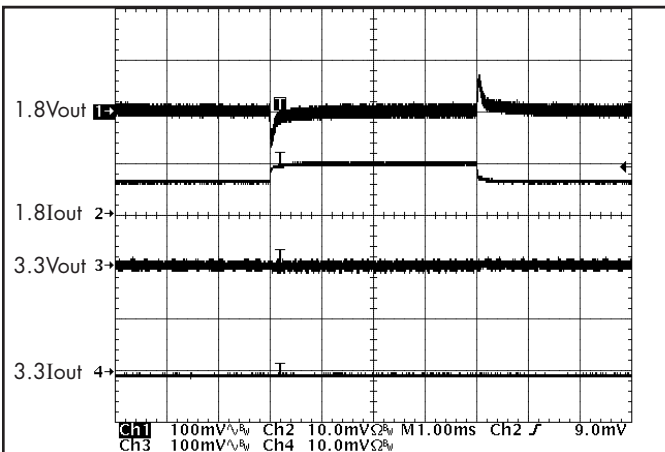

Figure 15: Output voltage response to step-change in I_{out1} (50%-75%-50% of I_{max} ; $di/dt = 0.1A/\mu s$). Load cap: $15\mu F$, $300\text{ m}\Omega$ ESR tantalum & $1\mu F$ ceramic. V_{out} (100mV/div), I_{out} (10A/div). Ch1: V_{out1} ; Ch2 I_{out1} ; Ch 3: V_{out2} ; Ch 4 I_{out2}

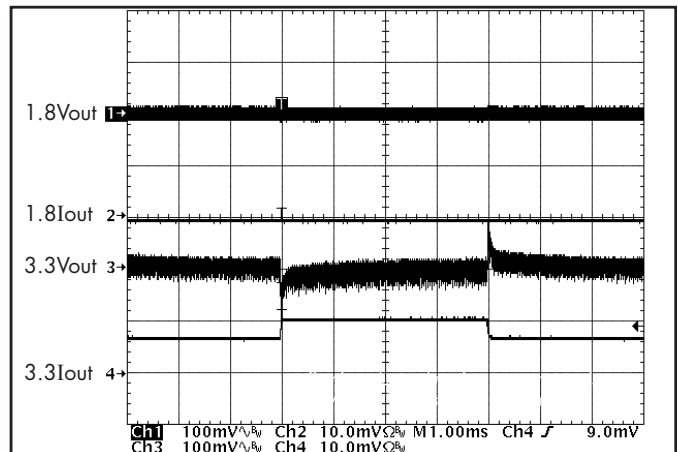

Figure 16: Output voltage response to step-change in I_{out2} (50%-75%-50% of I_{max} ; $di/dt = 0.1A/\mu s$). Load cap: $15\mu F$, $300\text{ m}\Omega$ ESR tantalum & $1\mu F$ ceramic. V_{out} (100mV/div), I_{out} (10A/div). Ch1: V_{out1} ; Ch2 I_{out2} ; Ch 3: V_{out2} ; Ch 4 I_{out2}

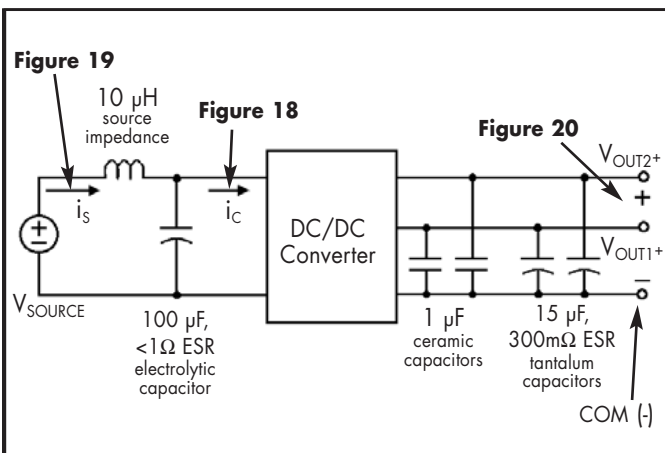

Figure 17: Test set-up diagram showing measurement points for Input Terminal Ripple Current (Figure 18), Input Reflected Ripple Current (Figure 19) and Output Voltage Ripple (Figure 20).

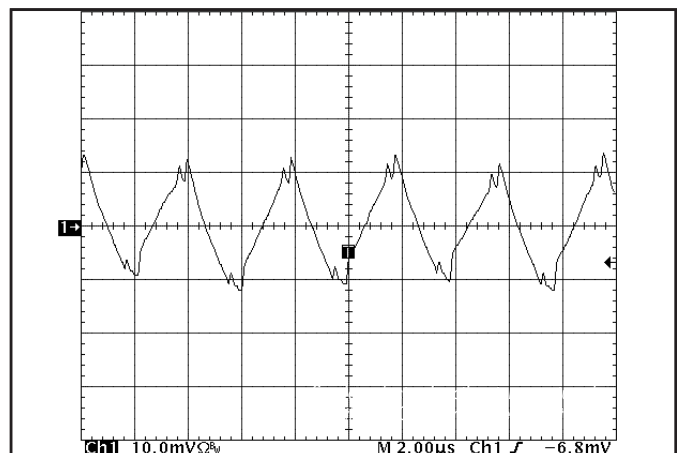

Figure 18: Input Terminal Ripple Current, 1.8V & 3.3V outputs at full rated output current and nominal input voltage with $10\mu H$ source impedance and $100\mu F$ electrolytic capacitor (10 mA/div). (see Fig. 17)

Performance Curves

Quarter Brick Dual $48V_{in}$ $3.3/1.8V_{out}$ $77W$

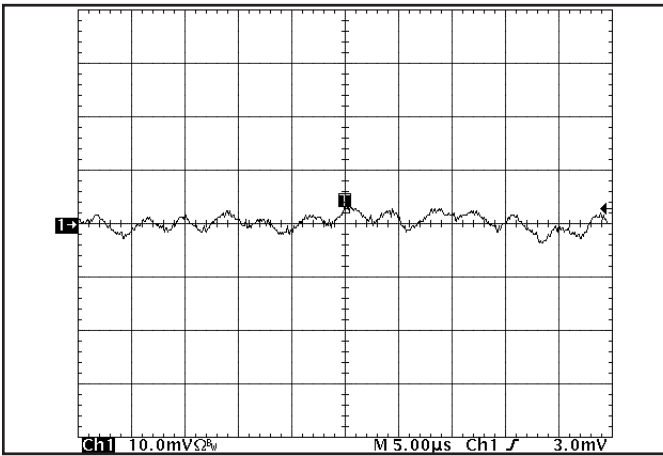

Figure 19: Input Reflected Ripple Current, i_s , through a $10 \mu H$ source inductor at nominal input voltage and rated load current (5 mA/div). 1.8V and 3.3V outputs at full rated load current. (see Fig. 17)

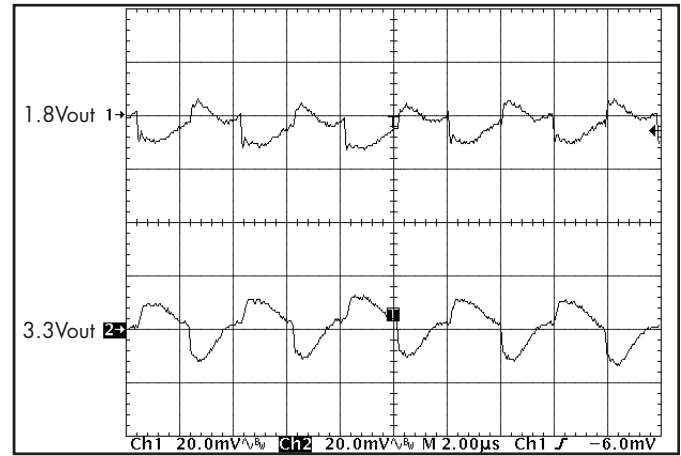

Figure 20: Output Voltage Ripple at nominal input voltage and rated load current on both outputs (20 mV/div). Load capacitance: $1 \mu F$ ceramic & $15 \mu F$ tantalum. Bandwidth: 20 MHz. (see Fig. 17)

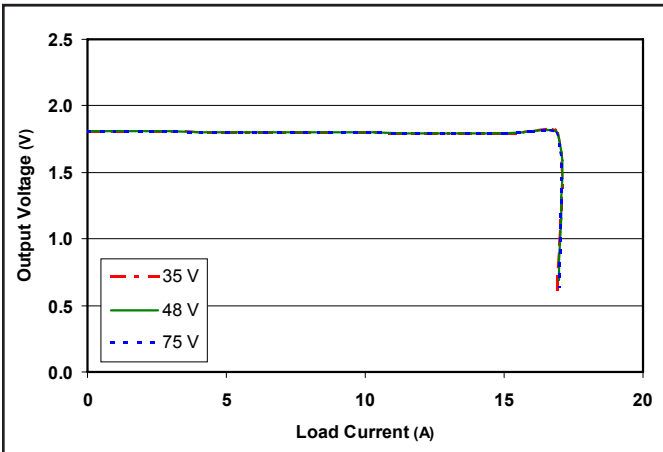

Figure 21: Output voltage vs. load current showing typical current limit curves and converter shutdown points for the 1.8V output. 3.3V load is at 0A.

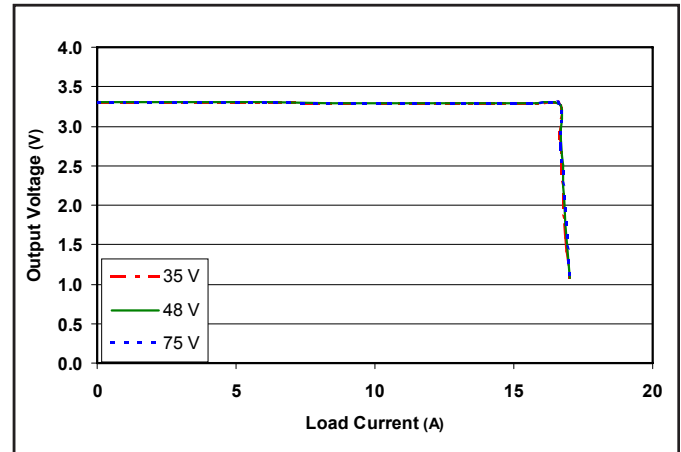

Figure 22: Output voltage vs. load current showing typical current limit curves and converter shutdown points for the 3.3V output. 1.8V load is at 0A.

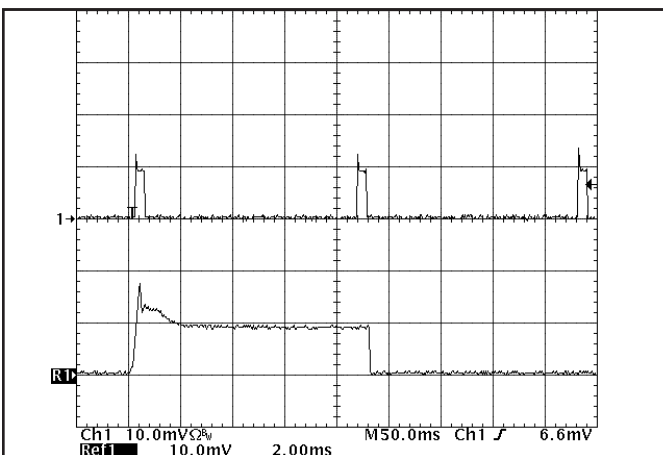

Figure 23: Load current for 1.8V output (20A/div) as a function of time when the converter attempts to turn on into a $10 m\Omega$ short circuit. Bottom trace is an expansion of the on-time portion of the top trace.

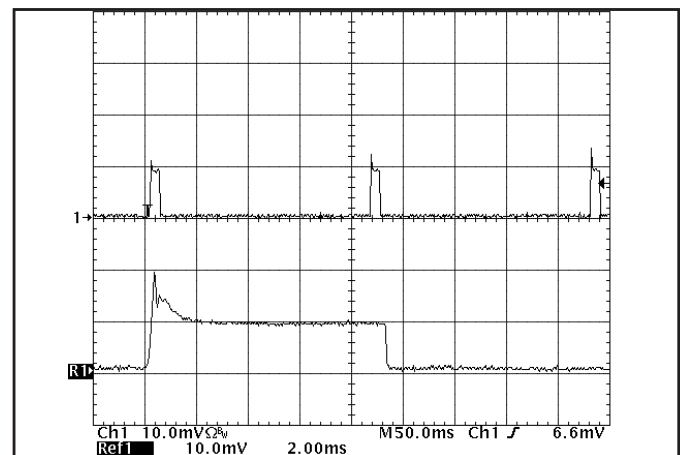

Figure 24: Load current for 3.3V output (20A/div) as a function of time when the converter attempts to turn on into a $10 m\Omega$ short circuit. Bottom trace is an expansion of the on-time portion of the top trace.

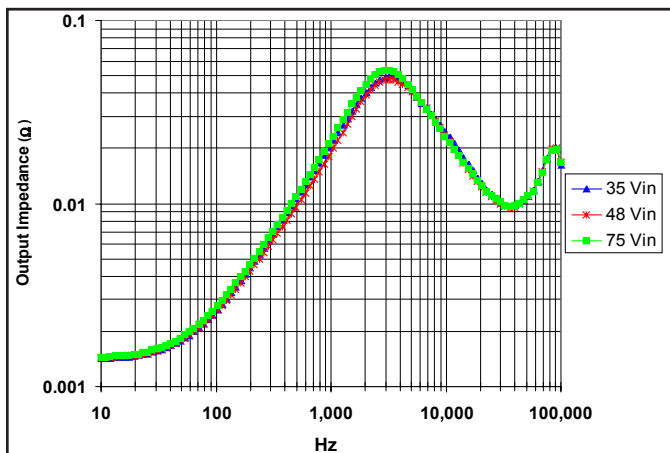

Figure 25: Output impedance ($Z_{out1} = V_{out1}/I_{out1}$) for minimum, nominal, and maximum input voltage at full rated power, for 1.8V output.

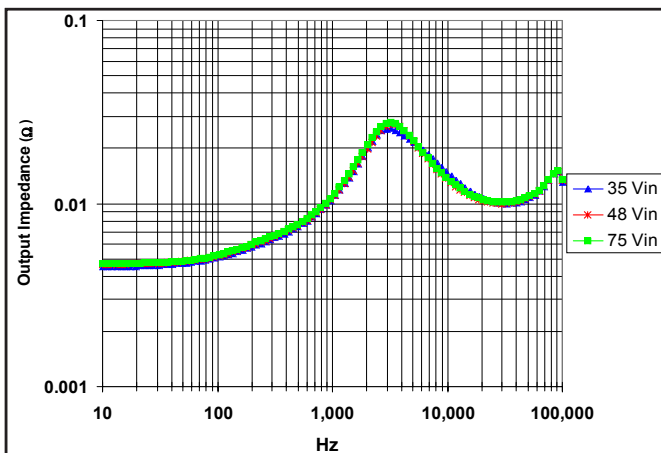

Figure 26: Output impedance ($Z_{out2} = V_{out2}/I_{out2}$) for minimum, nominal, and maximum input voltage at full rated power, for 3.3V output.

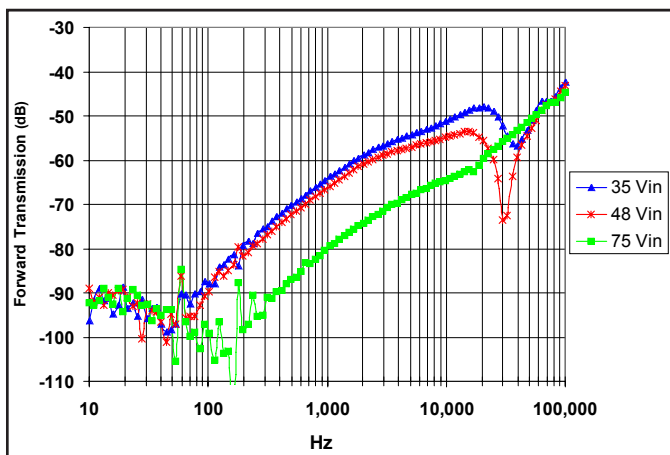

Figure 27: Forward Transmission ($FT_1 = V_{out1}/V_{in}$) for minimum, nominal, and maximum input voltage at full rated power, for 1.8V output.

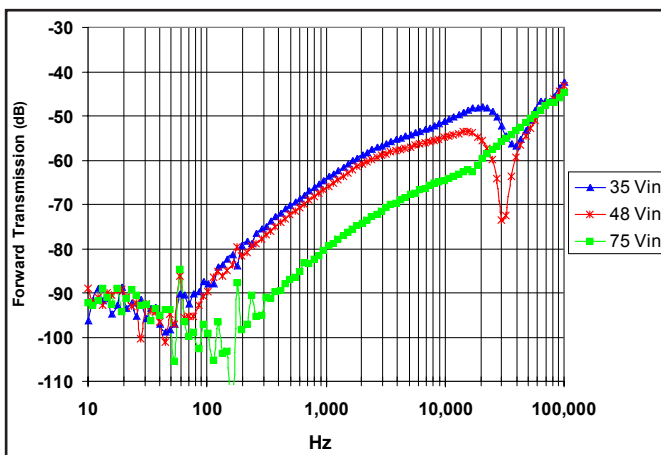

Figure 28: Forward Transmission ($FT_2 = V_{out2}/V_{in}$) for minimum, nominal, and maximum input voltage at full rated power, for 3.3V output.

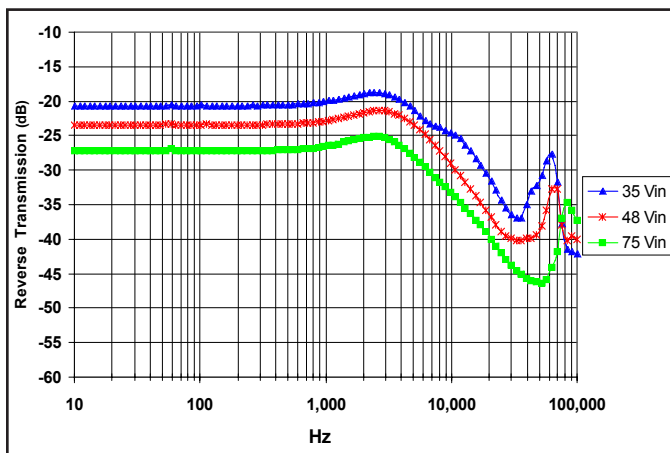

Figure 29: Reverse Transmission ($RT_1 = I_{in}/I_{out1}$) for minimum, nominal, and maximum input voltage at full rated power, for 1.8V output.

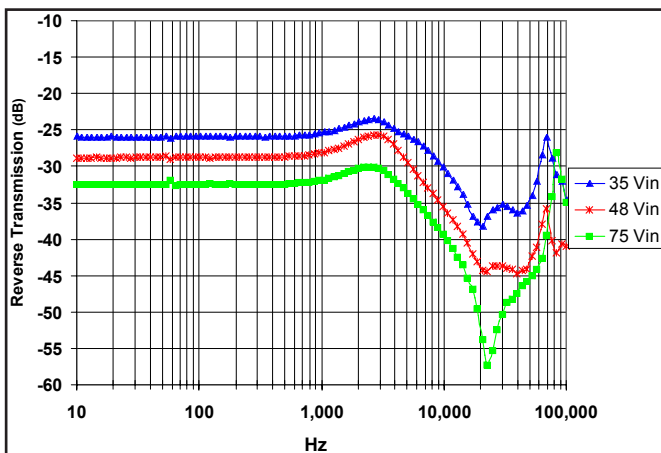

Figure 30: Reverse Transmission ($RT_2 = I_{in}/I_{out2}$) for minimum, nominal, and maximum input voltage at full rated power, for 3.3V output.

Performance Curves

**Quarter
Brick Dual** **48V_{in}** **3.3/1.8V_{out}** **77W**

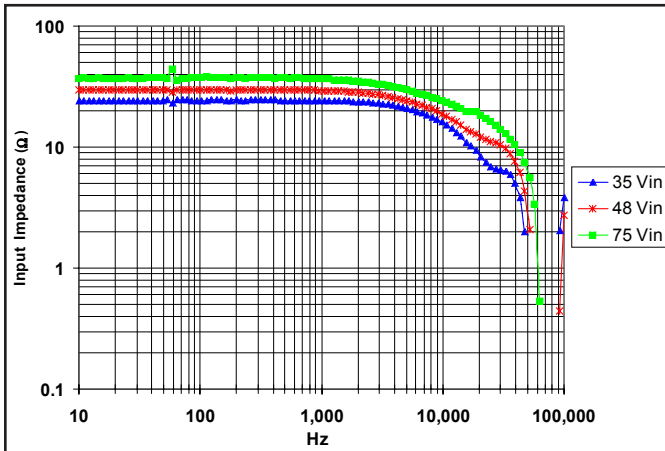

Figure 31: Input impedance ($Z_{in} = V_{in}/I_{in}$) for minimum, nominal, and maximum input voltage at full rated power for 1.8V output.

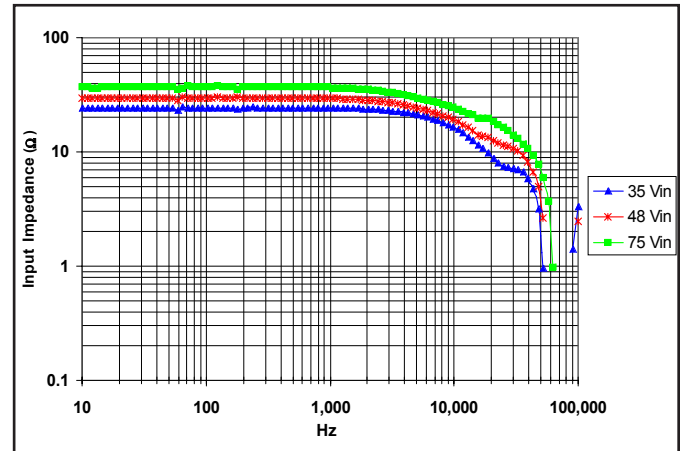

Figure 32: Input impedance ($Z_{in} = V_{in}/I_{in}$) for minimum, nominal, and maximum input voltage at full rated power for 3.3V output.

BASIC OPERATION AND FEATURES

The *DualQor* series converter uses a two-stage power circuit topology in which the two output voltages are cross regulated. The first stage is a buck-converter that keeps the output voltage constant over variations in line, load, and temperature. The second stage uses a transformer to provide the functions of input/output isolation and voltage step-down to achieve the low output voltage required.

The two-stage solution is ideal for converters with multiple cross-regulated output voltages. The first-stage compensates for any variations in line voltage. Therefore, the dependence of the output voltage on line variations is minimized.

Both the first stage and the second stage switch at a fixed frequency for predictable EMI performance. Rectification of the transformer's output is accomplished with synchronous rectifiers. These devices, which are MOSFETs with a very low on-state resistance, dissipate far less energy than Schottky diodes. This is the primary reason that the *DualQor* series of converters has such high efficiency, even at very low output voltages and very high output currents.

Dissipation throughout the converter is so low that it does not require a heatsink for operation. However, baseplated versions are available for optional heatsinking in severe thermal environments.

The *DualQor* series converter uses the industry standard footprint and pin-out configuration.

The *DualQor* has many standard control and protection features. All shutdown features are non-latching, meaning that the converter shuts off for 200 ms before restarting. (See Figure F)

CONTROL FEATURES

REMOTE ON/OFF (Pin 2): The ON/OFF input, Pin 2, permits the user to control when the converter is on or off. This input is referenced to the return terminal of the input bus, Vin(-). There are two versions of the converter that differ by the sense of the logic used for the ON/OFF input.

In the positive logic version, the ON/OFF input is active high (meaning that a high turns the converter on). In the negative logic version, the ON/OFF signal is active low (meaning that a low turns the converter on). Figure A details five possible circuits for driving the ON/OFF pin. Figure B is a detailed look of the internal ON/OFF circuitry.

OUTPUT VOLTAGE TRIM (Pin 6): The TRIM input permits the user to adjust the output voltage up or down according to the trim range specifications. It is important to recognize that adjusting one output will also adjust the second output proportionally. To lower the output voltage, the user should connect a resistor between Pin 6 and Pin 4. To raise the output voltage, the user should connect a resistor between Pin 6 and Pin 5. The following table shows the resistor values needed to trim the output voltage up or down.

Vo(%)	1	2	3	4	5	6	7	8	9	10
R up	54.9	24.9	14.3	9.31	6.34	4.32	2.80	1.69	0.83	0
R down	68.1	30.1	17.8	11.5	7.68	5.36	3.48	2.10	1.05	0

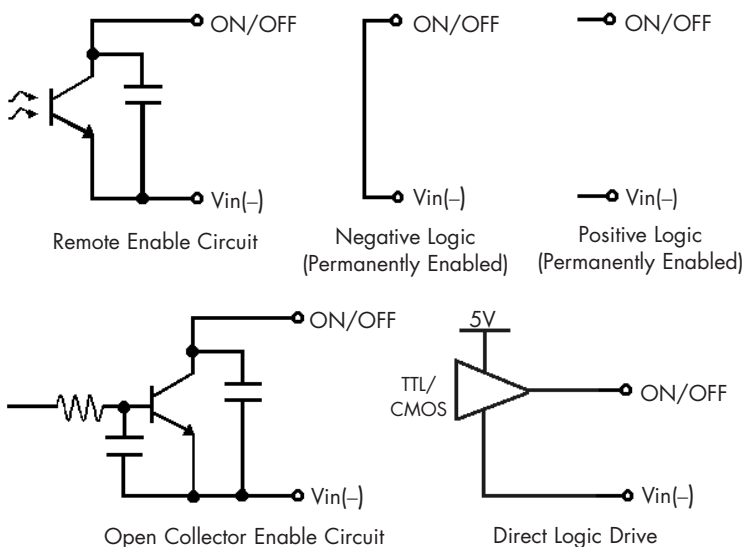

Figure A: Various circuits for driving the ON/OFF pin.

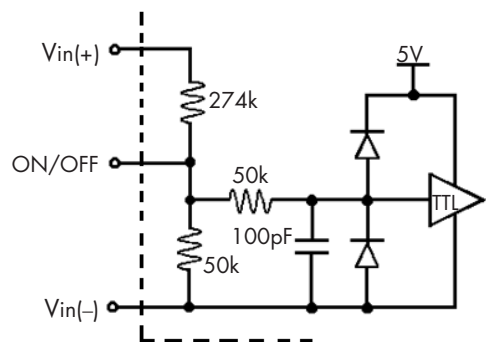

Figure B: Internal ON/OFF pin circuitry

Resistor values in Kohms for the desired increase/decrease (typical) in output voltage (%)

Note: The TRIM feature does not affect the voltage at which the output over-voltage protection circuit is triggered. Trimming the output voltage too high may cause the over-voltage protection circuit to engage, particularly during transients.

Total DC Variation of V_{out}: For the converter to meet its full specifications, the maximum variation of the DC value of V_{out}, due to both trimming and remote load voltage drops, should not be greater than that specified for the output voltage trim range.

PROTECTION FEATURES

Input Under-Voltage Lockout: The converter is designed to turn off when the input voltage is too low, helping avoid an input system instability problem, described in more detail in the application note titled "Input System Instability". The lockout circuitry is a comparator with DC hysteresis. When the input voltage is rising, it must exceed the typical Turn-On Voltage Threshold value (listed on the specification page) before the converter will turn on. Once the converter is on, the input voltage must fall below the typical Turn-Off Voltage Threshold value before the converter will turn off.

Output Current Limit: The maximum current limit remains constant as the output voltage drops. However, once the impedance of the short across the output is small enough to make the output voltage drop below the specified Output DC Current-Limit Shutdown Voltage, the converter turns off.

The converter then enters a "hiccup mode" where it repeatedly turns on and off at a 5 Hz (nominal) frequency with a 5% duty cycle until the short circuit condition is removed. This prevents

excessive heating of the converter or the load board.

Output Over-Voltage Limit: If the voltage across the output pins exceeds the Output Over-Voltage Protection threshold, the converter will immediately stop switching. This prevents damage to the load circuit due to 1) excessive series resistance in output current path from converter output pins to sense point, 2) a release of a short-circuit condition, or 3) a release of a current limit condition. Load capacitance determines exactly how high the output voltage will rise in response to these conditions. After 200 ms the converter will automatically restart.

Over-Temperature Shutdown: A temperature sensor on the converter senses the average temperature of the module. The thermal shutdown circuit is designed to turn the converter off when the temperature at the sensed location reaches the Over-Temperature Shutdown value. It will allow the converter to turn on again when the temperature of the sensed location falls by the amount of the Over-Temperature Shutdown Restart Hysteresis value.

APPLICATION CONSIDERATIONS

Input System Instability: This condition can occur because any DC/DC converter appears incrementally as a negative resistance load. A detailed application note titled "Input System Instability" is available on the SynQor web site (www.synqor.com) which provides an understanding of why this instability arises, and shows the preferred solution for correcting it.

Application Circuits: Figure D below provides a typical circuit diagram which details the input filtering and voltage trimming.

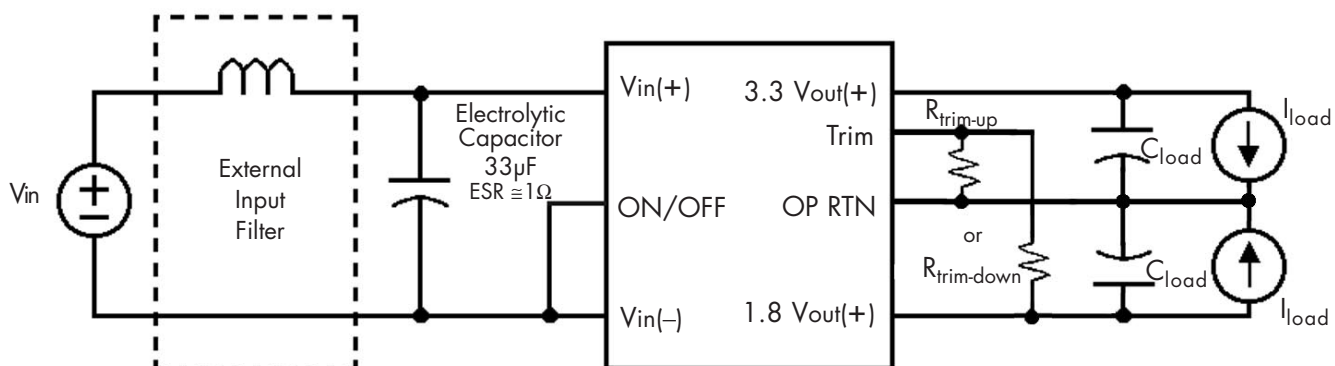

Figure D: Typical application circuit (negative logic unit, permanently enabled).

Input Filtering and External Capacitance: Figure E provides a diagram showing the internal input filter components. This filter dramatically reduces input terminal ripple current, which otherwise could exceed the rating of an external electrolytic input capacitor. The recommended external input capacitance is specified in the "Input Characteristics" section. More detailed information is available in the application note titled "EMI Characteristics" on the SynQor website.

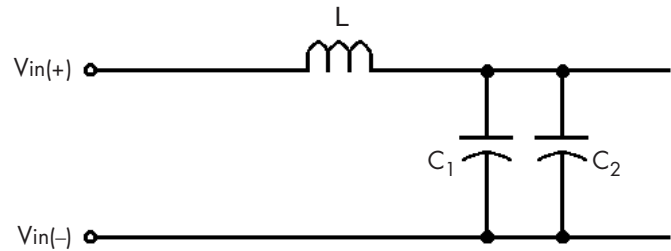

Figure E: Internal Input Filter Diagram (values listed on page 3).

Startup Inhibit Period: The Startup Inhibit Period ensures that the converter will remain off for at least 200ms when it is shut down for any reason. When an output short is present, this generates a 5Hz "hiccup mode," which prevents the converter from overheating. In all, there are seven ways that the converter can be shut down, initiating a Startup Inhibit Period:

- Input Under-Voltage Lockout
- Input Over-Voltage Shutdown (not present in Quarter-brick)
- Output Over-Voltage Protection
- Over Temperature Shutdown
- Current Limit
- Short Circuit Protection
- Turned off by the ON/OFF input

Figure F shows three turn-on scenarios, where a Startup Inhibit Period is initiated at t_0 , t_1 , and t_2 :

Before time t_0 , when the input voltage is below the UVL threshold, the unit is disabled by the Input Under-Voltage Lockout feature. When the input voltage rises above the UVL threshold, the Input Under-Voltage Lockout is released, and a Startup Inhibit Period is initiated. At the end of this delay, the ON/OFF pin is evaluated, and since it is active, the unit turns on.

At time t_1 , the unit is disabled by the ON/OFF pin, and it cannot be enabled again until the Startup Inhibit Period has elapsed.

When the ON/OFF pin goes high after t_2 , the Startup Inhibit Period has elapsed, and the output turns on within the typical Turn-On Time.

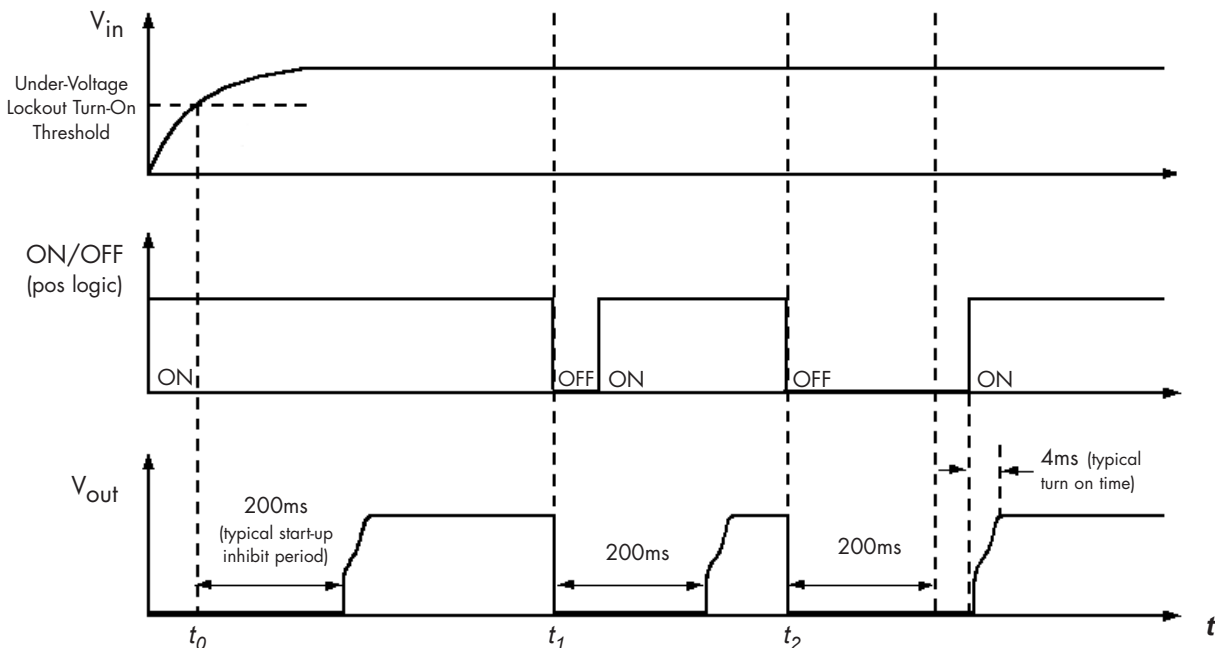

Figure F: Startup Inhibit Period (turn-on time not to scale)



Technical Specification

**Quarter
Brick Dual** **48V_{in} 3.3/1.8V_{out} 77W**

PART NUMBERING SYSTEM

The part numbering system for SynQor's *DualQor* DC/DC converters follows the format shown in the example below.

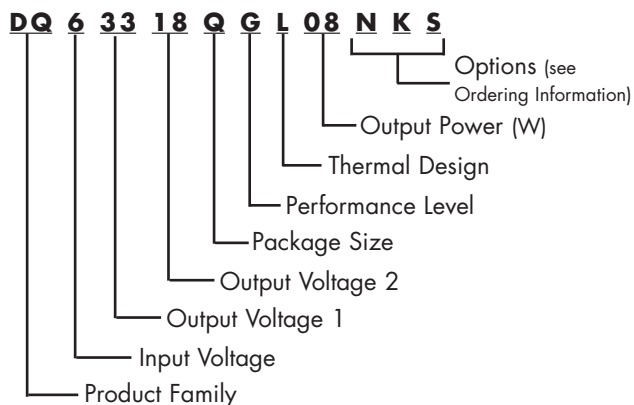

The first 12 characters comprise the base part number and the last 3 characters indicate available options. Although there are no default values for options, the most common options are negative logic, 0.145" pins and standard feature set. These part numbers are more likely to be readily available in stock for evaluation and prototype quantities.

Application Notes

A variety of application notes and technical white papers can be downloaded in pdf format at www.synqor.com.

Contact SynQor for further information:

Phone: 508-485-8434
Toll Free: 888-567-9596
Fax: 508-485-8414
E-mail: sales@synqor.com
Web: www.synqor.com
Address: 188 Central Street
 Hudson, MA 01749

ORDERING INFORMATION

Refer to the website for the most current list of valid model numbers and ordering options for converters in this product family. When ordering SynQor converters, please ensure that you use the complete 15 character part number consisting of the 12 character base part number and the additional 3 characters for options.

Model Number	Input Voltage	Output Voltages	Max Output Power
DQ63312QGL07xyz	35 - 75 V	3.3/1.2 V	68 W
DQ63315QGL07xyz	35 - 75 V	3.3/1.5 V	72 W
DQ63315QGL08xyz	35 - 75 V	3.3/1.5 V	80 W
DQ63318QGL08xyz	35 - 75 V	3.3/1.8 V	77 W
DQ63325QGL09xyz	35 - 75 V	3.3/2.5 V	87 W
DQ65033QGL10xyz	35 - 75 V	5.0/3.3 V	100 W
DQ63312QGA07xyz	35 - 75 V	3.3/1.2 V	68 W
DQ63315QGA07xyz	35 - 75 V	3.3/1.5 V	72 W
DQ63315QGA08xyz	35 - 75 V	3.3/1.5 V	80 W
DQ63318QGA08xyz	35 - 75 V	3.3/1.8 V	77 W
DQ63325QGA09xyz	35 - 75 V	3.3/2.5 V	87 W
DQ65033QGA10xyz	35 - 75 V	5.0/3.3 V	100 W

Modules listed above with QGA in part number have an increased bottom side board clearance and a slightly larger total height (see page 2 for dimensions). There are no other differences from the QGL units.

The following option choices must be included in the last three places of the model number.

Options Description		
Enable Logic	Pin Length	Feature Set
P - Positive N - Negative	K - 0.110" N - 0.145" R - 0.180" Y - 0.250"	S - Standard T - 2nd Trim pin

Warranty

SynQor offers a three (3) year limited warranty. Complete warranty information is listed on our web site or is available upon request from SynQor.

Information furnished by SynQor is believed to be accurate and reliable. However, no responsibility is assumed by SynQor for its use, nor for any infringements of patents or other rights of third parties which may result from its use. No license is granted by implication or otherwise under any patent or patent rights of SynQor.